



# Super Multi Blue Player

## Owner's Manual

MODEL: BH100



HD DVD

Before connecting, operating or adjusting this product,  
please read this instruction booklet carefully and completely.





**CAUTION: TO REDUCE THE RISK OF ELECTRIC SHOCK DO NOT REMOVE COVER (OR BACK) NO USER-SERVICEABLE PARTS INSIDE REFER SERVICING TO QUALIFIED SERVICE PERSONNEL.**



This lightning flash with arrowhead symbol within an equilateral triangle is intended to alert the user to the presence of uninsulated dangerous voltage within the product's enclosure that may be of sufficient magnitude to constitute a risk of electric shock to persons.



The exclamation point within an equilateral triangle is intended to alert the user to the presence of important operating and maintenance (servicing) instructions in the literature accompanying the product.

**WARNING: TO PREVENT FIRE OR ELECTRIC SHOCK HAZARD, DO NOT EXPOSE THIS PRODUCT TO RAIN OR MOISTURE.**

**WARNING:** Do not install this equipment in a confined space such as a book case or similar unit.

**CAUTION:**

Do not block any ventilation openings. Install in accordance with the manufacturer's instructions.

Slots and openings in the cabinet are provided for ventilation and to ensure reliable operation of the product and to protect it from over heating.

The openings should be never be blocked by placing the product on a bed, sofa, rug or other similar surface. This product should not be placed in a built-in installation such as a bookcase or rack unless proper ventilation is provided or the manufacturer's instruction have been adhered to.

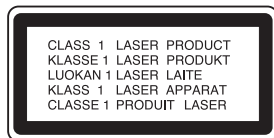

**CAUTION: CLASS 3B VISIBLE AND INVISIBLE LASER RADIATION WHEN OPEN AND INTERLOCKS DEFEATED AVOID EXPOSURE TO THE BEAM.**

**CAUTION:**

This product employs a Laser System.

To ensure proper use of this product, please read this owner's manual carefully and retain it for future reference. Should the unit require maintenance, contact an authorized service centre.

Performing controls, adjustments, or carrying out procedures other than those specified herein may result in hazardous radiation exposure.

To prevent direct exposure to laser beam, do not try to open the enclosure. Visible laser radiation when open. **DO NOT STARE INTO BEAM.**

**CAUTION:** The apparatus should not be exposed to water (dripping or splashing) and no objects filled with liquids, such as vases, should be placed on the apparatus.

**CAUTION concerning the Power Cord**

**Most appliances recommend they be placed upon a dedicated circuit;**

That is, a single outlet circuit which powers only that appliance and has no additional outlets or branch circuits. Check the specification page of this owner's manual to be certain.

Do not overload wall outlets. Overloaded wall outlets, loose or damaged wall outlets, extension cords, frayed power cords, or damaged or cracked wire insulation are dangerous. Any of these conditions could result in electric shock or fire. Periodically examine the cord of your appliance, and if its appearance indicates damage or deterioration, unplug it, discontinue use of the appliance, and have the cord replaced with an exact replacement part by an authorized servicer.

Protect the power cord from physical or mechanical abuse, such as being twisted, kinked, pinched, closed in a door, or walked upon. Pay particular attention to plugs, wall outlets, and the point where the cord exits the appliance.

To disconnect power from the mains, pull out the mains cord plug. When installing the product, ensure that the plug is easily accessible.

- The appliance is not intended for use by young children or infirm persons without supervision.
- Young Children should be supervised to ensure that they do not play with appliance.
- If the appliance is supplied from a cord extension set or an electrical portable outlet device, the cord extension set on electrical portable outlet device must be positioned so that it is not subject to splashing or ingress of moisture.

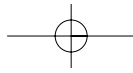

# Contents

<b>Introduction</b> .....	<b>4-10</b>
About the ∅ Symbol Display .....	4
Symbols Used in this Manual .....	4
Notes on Discs .....	4
Moisture Condensation .....	4
Playable Discs .....	5
Regional Code .....	5
Notes on Copyrights .....	5
BD-ROM Disc Features .....	6
HD DVD Disc Features .....	7
Compatibility Notes .....	7
Certain System Requirements .....	7
Important Notice for TV colour system .....	7
Front Panel .....	8
Display Window .....	9
Remote Control .....	10
<b>Installation and Setup</b> .....	<b>11-19</b>
Rear Panel .....	11
HDMI connection .....	12
Connections to Your TV .....	13
Connecting to an Amplifier .....	14
Resolution Setting .....	15
Initial Settings .....	16
- General Operation .....	16
- Display Menu .....	16
- Language Menu .....	17
- Audio Menu .....	17-18
- Lock Menu (Parental Control) .....	19
- Others Menu .....	19
<b>Operations</b> .....	<b>20-22</b>
General playback features .....	20
If a disc menu screen is displayed .....	21
Time Search .....	21
Marker Search .....	21
Using Colour Buttons .....	21
Displaying Disc Information On-Screen .....	21
Special Features for HD DVD .....	22
- HD DVD Twin Format Discs .....	22
- Using the HD DVD with HDi features .....	22
- Multi Title List function .....	22
Special Features for BD-ROM .....	22
- BD Hybrid Discs .....	22
<b>Reference</b> .....	<b>23-30</b>
Controlling an LG TV with the Supplied Universal Remote Control .....	23
Controlling other TVs with the Universal Remote Control .....	23
Code numbers of controllable TVs .....	24-25
Language Codes .....	26
Area Codes .....	26
Troubleshooting .....	27
Maintenance and Service .....	27
Specifications .....	28
Super Multi Blue Player's Audio Output Specifications .....	29
Open source software notice .....	30
Customer Support .....	30

# Introduction

To ensure proper use of this product, please read this owner's manual carefully and retain for future reference.

This manual provides information on the operation and maintenance of your player. Should the unit require service, contact an authorized service location.

## About the Symbol Display

" " may appear on your TV display during operation and indicates that the function explained in this owner's manual is not available on that specific media.

## Symbols Used in this Manual



### Note:

Indicates special notes and operating features.

### Tip:

Indicates tips and hints for making the task easier.

A section whose title has one of the following symbols are applicable only to the disc represented by the symbol.

-  BD-ROM disc
-  HD DVD-ROM disc
-  DVD-Video disc

Manufactured under license from Dolby Laboratories. "Dolby", "Pro Logic", and the double-D symbol are trademarks of Dolby Laboratories.

DTS and DTS Digital Surround are registered trademarks of Digital Theater Systems, Inc.

## Notes on Discs

### Handling Discs

Do not touch the playback side of the disc. Hold the disc by the edges so that fingerprints do not get on the surface. Never stick paper or tape on the disc.

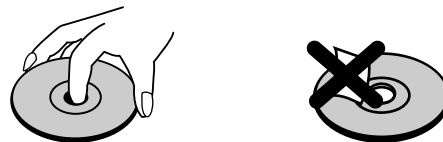

### Storing Discs

After playing, store the disc in its case. Do not expose the disc to direct sunlight or sources of heat and never leave it in a parked car exposed to direct sunlight.

### Cleaning Discs

Fingerprints and dust on the disc can cause poor picture quality and sound distortion. Before playing, clean the disc with a clean cloth. Wipe the disc from the centre out.

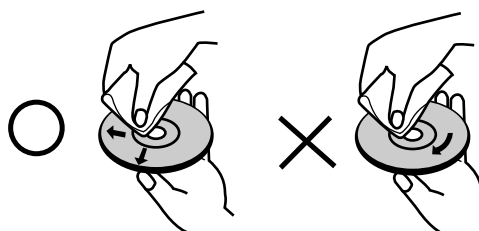

Do not use strong solvents such as alcohol, benzene, thinner, commercially available cleaners, or anti-static spray intended for older vinyl records.

## Moisture Condensation

Never operate this product immediately after moving it from a cold location to a warm location. Leave it for two or three hours without operating it. If you use this product in such a situation, it may damage discs and internal parts.

## Playable Discs



### BD-ROM

Discs such as movies that can be purchased or rented

### HD DVD Disc

This product fully supports standard Blu-ray discs and can play high definition audio/visual content from HD DVD discs. This product does not support interactive "HDi" features available from many HD DVD discs.



### DVD-VIDEO (8 cm / 12 cm disc)

Discs such as movies that can be purchased or rented



### DVD-R (8 cm / 12 cm disc)

Video mode and finalized only



### DVD-RW (8 cm / 12 cm disc)

Video mode and finalized only



### DVD+R

Video mode only  
Supports the dual layer disc also



### DVD+RW

Video mode only

### Notes:

- Depending on the conditions of the recording equipment or the DVD±R/RW disc itself, some DVD±R/RW discs cannot be played on the unit.
- Do not attach any seal or label to either side (the labelled side or the recorded side) of a disc.
- Do not use irregularly shaped discs (e.g., heart shaped or octagonal). Doing so may result in malfunctions.
- Depending on the recording software & the finalization, some recorded DVD±R/RW may not be playable.
- DVD±R/RW discs recorded using a personal computer or a DVD Recorder may not play if the disc is damaged or dirty, or if there is dirt or condensation on the Player's lens.
- If you record a disc using a personal computer, even if it is recorded in a compatible format, there are cases in which it may not play because of the settings of the application software used to create the disc. (Check with the software publisher for more detailed information.)

## Regional Code

Both the player and the discs are coded by region. These regional codes must match in order to play the disc. If the codes do not match, the disc will not play. The Region Number for this player is described on the rear panel of the player.



DVD-Video



BD-ROM

## Notes on Copyrights

- Because AACS (Advanced Access Content System) is approved as content protection system for BD and HD DVD format, similar to use of CSS (Content Scramble System) for DVD format, certain restrictions are imposed on playback, analog signal output, etc., of AACS protected contents. The operation of this product and restrictions on this product may vary depending on your time of purchase as those restrictions may be adopted and/or changed by AACS after the production of this product.  
Furthermore, BD-ROM Mark and BD+ are additionally used as content protection system for BD format, which imposes certain restrictions including playback restrictions for BD-ROM Mark and/or BD+ protected contents. To obtain additional information on AACS, BD-ROM Mark, BD+, or this product, please contact LG Customer Service Centre.
- Many HD DVD/BD-ROM/DVD discs are encoded with copy protection. Because of this, you should only connect your player directly to your TV, not to a VCR. Connecting to a VCR results in a distorted picture from copy-protected discs.
- This product incorporates copyright protection technologies that are protected by certain U.S. patents and other intellectual property rights owned by Macrovision Corporation and other rights owners. Use of this copyright protection technology must be authorized by Macrovision Corporation and is intended for home and other limited viewing uses only, unless otherwise authorized by Macrovision Corporation. Reverse engineering or disassembly is prohibited.
- Under the U.S. Copyright laws and Copyright laws of other countries, unauthorized recording, use, display, distribution, or revision of television programs, videotapes, HD DVDs, BD-ROM discs, DVDs, CDs and other materials may subject you to civil and/or criminal liability.

## BD-ROM Disc Features

BD-ROM Discs can store 25 GB (single layer) or 50 GB (dual layer) on a single sided disc - about 5 to 10 times the capacity of a DVD.

BD-ROM Discs also support the highest quality HD video available in the industry (up to 1920 x 1080) - Large capacity means no compromise on video quality. Furthermore, a BD-ROM disc has the same familiar size and look as DVD.

- The following BD-ROM disc features are disc dependent and will vary.
- Appearance and navigation of features will also vary from disc to disc.
- Not all discs will have the features described below.
- BD-ROM, Hybrid disc have both BD-ROM and DVD layers on one side. Because this type of disc is a technology currently in development, such discs may not operate properly in this player.

### Video highlights

The BD-ROM format for movie distribution supports three highly advanced video codecs, including MPEG-2, MPEG4 AVC (H.264), and SMPTE VC1. HD video resolutions are also available:

- 1920 x 1080 HD
- 1280 x 720 HD

### For High-Definition Playback

To view high-definition contents from BD-ROM discs, an HDTV is required. Some discs may require HDMI OUT for viewing of high-definition contents. Ability to view high-definition contents in BD-ROM discs may be limited depending on the resolution of your TV.

### Graphic planes

Two individual, full HD resolution (1920x1080) graphic planes (layers) are available, on top of the HD video layer. One plane is assigned to video related, frame accurate graphics (like subtitles), and the other plane is assigned to interactive graphic elements, such as buttons or menus.

For both planes, various wipes, fades and scroll effects may be available.



Graphic Plane

HD Video

### Menu graphics

Support 256 colour full resolution graphics and animation, thereby greatly surpassing the capabilities of DVD-Video. Options can be accessed and removed during video playback.

### Menu sounds

When you highlight or select a menu option, sounds can be heard such as button clicks or a voice-over explaining the highlighted menu choice.

### Multi-page/Pop Up Menus

With DVD-Video, playback is interrupted each time a new menu screen is accessed. Due to BD-ROM disc's ability to preload data from the disc without interrupting playback, a menu can consist of several pages.

You can browse through the menu pages or select different menu paths, while the audio and video remain playing in the background.

### Interactivity

Certain BD-ROM Discs may contain animated menus and/or trivia games.

### User Browsable Slideshows

With BD-ROM Discs, you can browse through various still pictures while the audio remains playing.

### Subtitles

Depending on what is contained on the BD-ROM disc, you may be able to select different font styles, sizes and colours for some subtitles, Subtitles may also be animated, scrolled or faded in and out.

### BD-Java Interactive Capability

This player supports JAVA contents in the BD-ROM disc.

### BD-ROM Disc Compatibility

BD-ROM disc is a new and evolving format.

Accordingly, disc compatibility issues with new and existing format discs are possible. Not all discs are compatible and not every disc will playback. For additional information, also refer to the Compliance and Compatibility Notice section of this Manual.

If you encounter compatibility problems, please contact LG Customer Service Centre.

This player supports only BD-ROM Profile 1 version 1.0 specification.

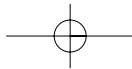

## HD DVD Disc Features

HD DVD video discs are high-density, high-capacity discs.

- There are 2 types of HD DVD disc; one is standard content disc and the other is advanced content disc. Standard content disc is pure extension of DVD Video. Advanced content disc realizes more interactivity in addition to the extension of audio and video realized by standard disc.
- The HD DVD disc standard has been approved by the DVD forum.
- HD DVD (single layer): Maximum capacity of 15 GB  
HD DVD (dual layer): Maximum capacity of 30 GB  
A single layer single sided disc (15 GB) has capacity of about maximum 8 hours in 1125 line high definition picture; about maximum 48 hours in 525 line standard definition picture (depending on bitrate of pre-recorded contents).
- HD DVD Twin Format Discs have both HD DVD and DVD layers on one side. HD DVD Combination DVD Discs have HD DVD material on one side and standard DVD material on the other side. Because this type of disc is a technology currently in development, such discs may not operate properly in this player.
- Some titles may played back with black "letterbox bars" because the title is recorded with bars by the content provider.
- This product fully supports standard Blu-ray discs and can play high definition audio/visual content from HD DVD discs. This product does not support interactive "HDi" features available from many HD DVD discs.

## Compatibility Notes

- Because BD-ROM and HD DVD are a new format, certain disc, digital connection and other compatibility issues are possible. If you experience compatibility problems, please contact LG Customer Service Centre.
- Viewing high-definition content and up-converting standard DVD content may require an HDMI capable input or HDCP capable DVI input on your display device.
- Some BD-ROM, HD DVD and DVD discs may restrict the use of some operation commands or features.
- Dolby Digital Plus and DTS-HD (DTS only) capability is limited to 6 channels (5.1).

## Certain System Requirements

For high definition video playback:

- High definition display that has COMPONENT or HDMI input jacks.
- BD-ROM or HD DVD disc with high definition content.
- HDMI or HDCP capable DVI input on your display device is required for some content (as specified by disc authors).
- For up-conversion of standard definition DVD, an HDMI or HDCP capable DVI input on your display device is required for copy protected content.

For Dolby® Digital Plus and DTS-HD multi-channel audio playback:

- A/V Receiver or processor/amp combination with 5.1 channel analog input.
- Main, centre, surround speakers and subwoofer as necessary for chosen format.

## Important Notice for TV colour system

The colour system of this player differs according to currently playing discs.

For example, when the player plays back the disc recorded in the NTSC colour system, the image is outputted as a NTSC signal.

Only the multi system colour TV can receive all signals outputted from the player.

### Notes:

- If you have a PAL colour system TV, you will see just distorted images when using discs recorded in NTSC.
- The multi system colour TV changes the colour system automatically according to input signals. In case that the colour system is not changed automatically, turn it off and then on to see normal images on screen.
- If you try to record a NTSC output signal from the player with your recorder, the recorder may not record the signal correctly.

## Front Panel

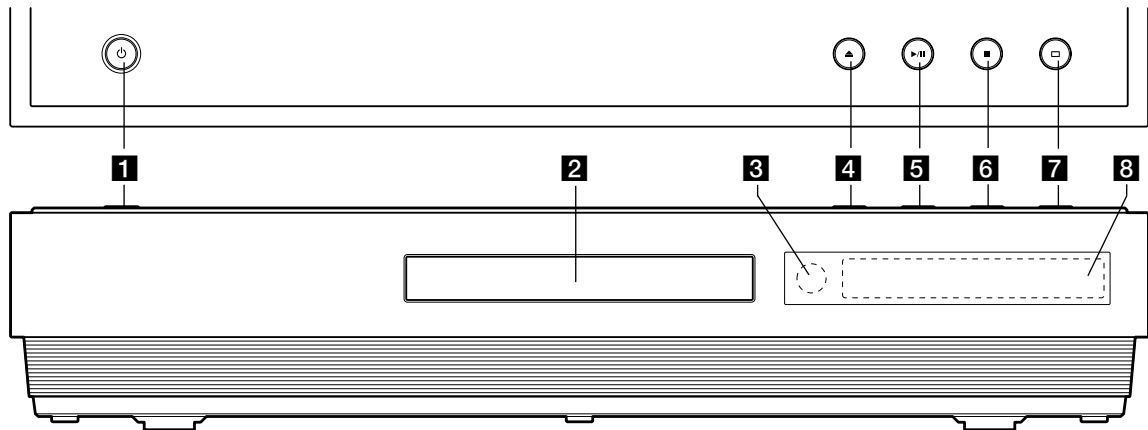

### 1 POWER Button

Switches the unit ON or OFF.

### 2 Disc Tray

Insert a disc here.

### 3 Remote Sensor

Point the Remote Control here.

### 4 ▲ (OPEN/CLOSE)

Opens or closes the disc tray.

### 5 ► / || (PLAY / PAUSE)

Starts playback.

Pause playback temporarily, press again to exit pause mode.

### 6 ■ (STOP)

Stops playback.

### 7 □ (RESOLUTION)

Sets the output resolution for HDMI and COMPONENT VIDEO OUT jacks.

### 8 Display Window

Shows the current status of the player.

### Tip:

▲, ► / ||, ■, and □ buttons are operated with a slight/brief touch.

### Precautions in using the touch buttons

- Use the touch buttons with clean and dry hands.
- Do not press the touch buttons with too much force.
- Do not touch the button with any conductive material such as metallic object (Disc, etc). It may cause a malfunction.

### Lock (Child Lock)

The ► / ||, ■, and □ buttons on the front of the player can be locked so that your player can only be operated using the Remote Control.

1. Press LOCK on the Remote Control. "LOCK ON" will appear in the display window.  
If ► / ||, ■ or □ button on the front of your unit are pressed, "CHILD LOCK" will flicker in the display window for a few seconds.
2. Press LOCK again to switch off the child lock. "LOCK OFF" will appear in the display window.

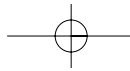

## Display Window

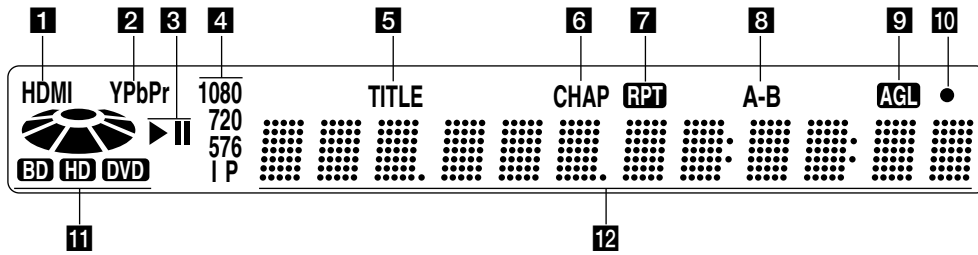

- 1 HDMI Indicator**  
Indicates when the HDMI output is available.
- 2 YPbPr Indicator**  
Indicates when the component video output is available.
- 3 Status Indicator**  
▶: Playing  
||: Paused
- 4 Video Output Resolution Indicator**  
Displays the video output resolution currently selected.  
576i: 576 interlaced  
576p: 576 progressive  
720p: 720 progressive  
1080i: 1080 interlaced  
1080p: 1080 progressive
- 5 TITLE**  
Indicates current title number.
- 6 CHAP (Chapter) Indicator**  
Indicates current chapter number.
- 7 Repeat Mode Indicator**  
Indicates when playing in repeat mode.
- 8 A-B Repeat Mode Indicator**  
Indicates when playing in A-B repeat mode.
- 9 AGL (Angle) Indicator**  
Indicates when playing a scene recorded with multi angles.
- 10 Remote Control Indicator**  
Indicates when Remote Control signal is received.
- 11 Disc Indicator**  
BD: Indicates when an BD-ROM disc is loaded.  
HD DVD: Indicates when an HD DVD disc is loaded.  
DVD: Illuminates when a DVD disc is loaded.
- 12 Character Indicators**  
Indicates total playing time, elapsed time, title number, chapter number or message, etc.

## Remote Control

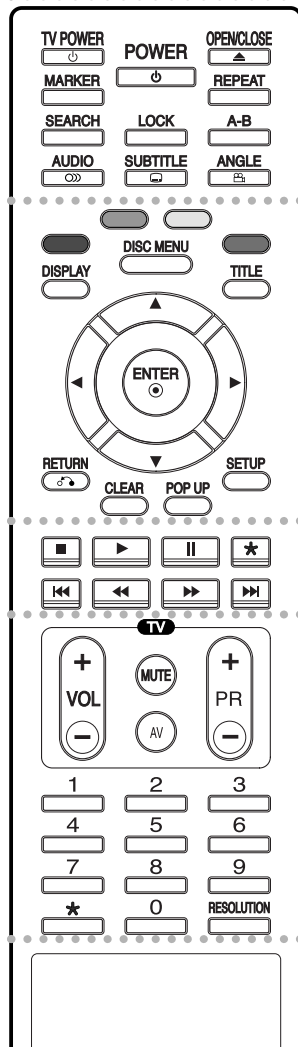

• • • • • **1** • • • • •

**POWER:** Switches the player ON or OFF.

**TV POWER:** Switches the TV ON or OFF.

**OPEN/CLOSE (▲):** Opens and closes the disc tray.

**MARKER:** Marks any point during playback.

**SEARCH:** Displays Marker Search menu.

**AUDIO (⏮):** Selects an audio language or audio channel.

**LOCK:** Press to lock the ► / II, ■, and □ buttons on the front panel. Press again to release.

**SUBTITLE (⏮):** Selects a subtitle language.

**REPEAT:** Repeat chapter, title.

**A-B:** Repeat sequence.

**ANGLE (⏮):** Selects a disc camera angle, if available.

• • • • • **2** • • • • •

**Colour Buttons:** Use these buttons as indicated by the video display during BD-ROM disc playback

**DISPLAY:** Accesses On-Screen Display.

**DISC MENU:** Accesses menu on a disc.

**TITLE:** Displays the disc's title menu, if available.

◀ / ▶ / ▲ / ▼

**(left/right/up/down):** Selects an option in the menu.

**ENTER (⊙):** Acknowledges menu selection.

**RETURN (↶):** Exits the menu.

**CLEAR:** Removes a mark on the Marker Search menu or a number when setting the password.

**POP UP:** Displays the disc's popup menu, if available. (BD-ROM only)

**SETUP:** Accesses or exits the Setup menu.

• • • • • **3** • • • • •

■ **(STOP):** Stops playback.

▶ **(PLAY):** Starts playback.

II **(PAUSE/STEP):** Pauses playback.

◀◀ / ▶▶ **(SCAN):** Search backward or forward.

◀◀◀ / ▶▶▶ **(SKIP):** Go to next or previous chapter.

• • • • • **4** • • • • •

**TV Control Buttons:** See page 23.

**0-9 numerical buttons:** Selects numbered options in a menu.

**RESOLUTION:** Sets the output resolution for HDMI and COMPONENT VIDEO OUT jacks.

\* buttons are not available.

## Remote Control Operation

Point the Remote Control at the remote sensor and press the buttons.

### Caution

Do not mix old and new batteries. Never mix different types of batteries (standard, alkaline, etc.).

## Remote Control Battery Installation

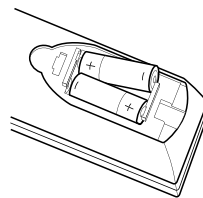

Remove the battery cover on the rear of the Remote Control, and insert two R03 (size AAA) batteries with + and - matched correctly.

# Installation and Setup

## Rear Panel

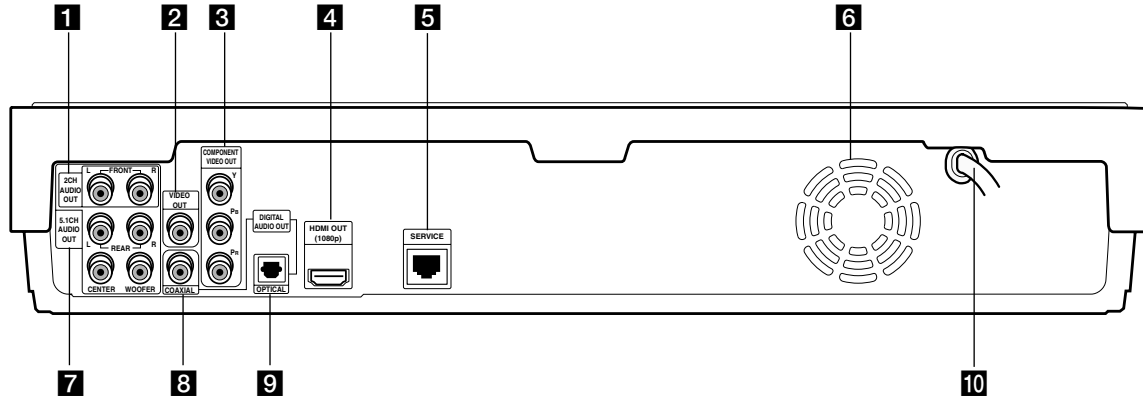

- 1** **2CH AUDIO OUT (Left/Right)**  
Connect to a TV with 2 channel audio inputs.
- 2** **VIDEO OUT**  
Connect to a TV with video inputs.
- 3** **COMPONENT VIDEO OUT (Y Pb Pr)**  
Connect to a TV with Y Pb Pr inputs.
- 4** **HDMI OUT (Type A)**  
Connect to TV with HDMI inputs. (Interface for digital audio and video)
- 5** **SERVICE port**  
Reserved for authorized service purposes.
- 6** **Cooling fan**
- 7** **5.1CH ANALOG AUDIO OUT**  
Connect to a 5.1CH analog input on an A/V Amplifier/Receiver.
- 8** **COAXIAL (Digital audio out jack)**  
Connect to digital (coaxial) audio equipment.
- 9** **OPTICAL (Digital audio out jack)**  
Connect to digital (optical) audio equipment.
- 10** **AC Power Cord**  
Plug into the power source.

## HDMI connection

If you have a HDMI TV or monitor, you can connect it to this player using a HDMI cable.

1. Connect the HDMI jack on the player to the HDMI jack on a HDMI compatible TV or monitor (**H**).
2. Set the TV's source to HDMI (refer to TV's Owner's manual).

### Notes:

- If your TV is NOT capable of handling 96 kHz sampling frequency, set the [Sampling Freq.] option to [48 kHz] on the setup menu (See page 17). When this choice is made, this unit will automatically convert any 96 kHz signals to 48 kHz so your system can decode them. (See page 17)
- If [SPDIF] option is set to [Bitstream] on the setup menu and your TV does not support Bitstream Audio out in HDMI connection, audio sound may be distorted or may not output. In this case, set the [SPDIF] option to [PCM] in the setup menu. (See page 17)
- Dolby Digital Plus and DTS-HD capability limited to 5.1 channels.
- Dolby TrueHD processing for two channels only.
- If a title or disc is recorded in a resolution lower than 1080p, the output resolution is automatically changed to no higher than 1080i (even if 1080p is selected in the menu).
- The arrow on the cable connector body should face up for correct alignment with the connector on the player.

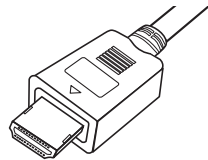

(Type A)

### Tip:

When you use HDMI connection, you can change the resolution for the HDMI output. (Refer to "Resolution Setting" on page 15.)

### Cautions

- Changing the resolution when the connection has already been established may result in malfunctions. To solve the problem, turn off the player and then turn it on again.
- When the HDMI connection with HDCP is not verified, a message appears on TV screen. In this case, check the the HDMI connection, or disconnect the HDMI cable.
- If there is noise or lines on the screen, please check the HDMI cable (length is generally limited to 15ft).

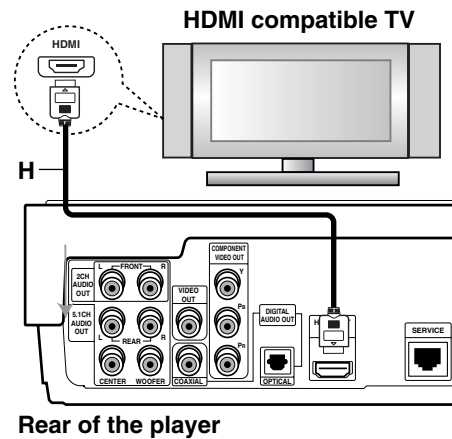

Rear of the player

### About HDMI

HDMI (High Definition Multimedia Interface) supports both video and audio on a single digital connection for use with DVD Players, Set-Top Boxes, and other AV devices.

HDMI was developed to provide the technologies of HDCP (High-Bandwidth Digital Contents Protection). HDCP is used to protect digital content transmitted and received.

HDMI has the capability to support standard, enhanced, or high-definition video plus standard to multi-channel surround-sound audio, HDMI features include uncompressed digital video, a bandwidth of up to 5 gigabytes per second, one connector (instead of several cables and connectors), and communication between the AV source and AV devices such as DTVs.

*HDMI, the HDMI logo and High-Definition Multimedia Interface are trademarks or registered trademarks of HDMI licensing LLC.*

### Additional Information for HDMI

- When you connect a HDMI or DVI compatible device make sure of the followings:
  - Try switching off the HDMI/DVI device and this player. Next, switch on the HDMI/DVI device and leave it for around 30 seconds, then switch on this player.
  - The connected device's video input is set correctly for this unit.
  - The connected device is compatible with 720x576p, 1280x720p, 1920x1080i or 1920x1080p video input. 1920x1080p is available only on BD-ROM / HD DVD recorded in 1080p.
- Not all HDCP-compatible DVI devices will work with this player.
  - The picture will not be displayed properly with non-HDCP device.
  - This player does not playback and a message appears on TV screen.

## Connections to Your TV

- Make one of the following connections, depending on the capabilities of your existing equipment.

### Tips

- Depending on your TV and other equipment you wish to connect, there are various ways you could connect the player. Use only one of the connections described below.
- Please refer to the manuals of your TV, Stereo System or other devices as necessary to make the best connections.

### Caution

- Make sure the player is connected directly to the TV. Tune the TV to the correct video input channel.
- Do not connect the player's AUDIO OUT jack to the phono in jack (record deck) of your audio system.
- Do not connect your player via your VCR. The DVD image could be distorted by the copy protection system.

### Component Video Connection

Connect the COMPONENT VIDEO OUT jacks on the player to the corresponding input jacks on the TV using Y Pb Pr cables (**C**).

### Tip:

When you use COMPONENT VIDEO OUT connection, you can change the resolution for the output. (Refer to "Resolution setting" on page 15.)

### Video Connection

Connect the VIDEO OUT jack on the player to the video in jack on the TV using a video cable (**V**).

### Audio (Left/Right) Connection

Connect the left and right AUDIO OUT jacks of the player to the audio left and right IN jacks on the TV using the audio cables (**A**). Do not connect the player's AUDIO OUT jack to the phono in jack (record deck) of your audio system.

### Note:

For this audio connection, set the [Speaker Out] option to [2CH] on the setup menu. (See page 17.)

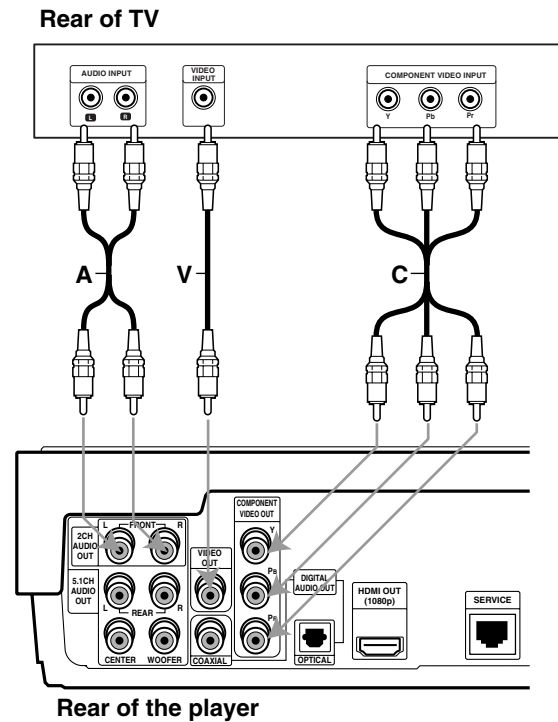

## Connecting to an Amplifier

### Connecting to an amplifier equipped with two channel analog stereo or Dolby Pro Logic II/ Pro Logic

Connect the Left and Right AUDIO OUT jacks on the player to the audio left and right in jacks on your amplifier, receiver, or stereo system, using audio cables (A).

### Connecting to an amplifier equipped with two channel digital stereo (PCM) or to an Audio/Video receiver equipped with a multi-channel decoder (Dolby Digital™, MPEG 2, or DTS)

1. Connect one of the player's DIGITAL AUDIO OUT jacks (OPTICAL O or COAXIAL X) to the corresponding in jack on your amplifier. Use an optional digital (optical O or coaxial X) audio cable.
2. You will need to activate the player's digital output. (See "Audio Menu" on pages 17.)

#### Notes:

- Dolby Digital Plus and DTS-HD capability limited to 5.1 channels.
- Dolby TrueHD processing for two channels only.

#### Digital Multi-channel sound

A digital multi-channel connection provides the best sound quality. For this you need a multi-channel Audio/Video Receiver that supports one or more of the audio formats supported by your player (MPEG 2, Dolby Digital and DTS). Check the receiver manual and the logos on the front of the receiver.

#### Cautions:

- Due to the DTS Licensing agreement, the digital output will be in DTS digital out when DTS audio stream is selected.
- Digital multi channel of the Dolby Digital, Dolby Digital Plus and True HD is output with Dolby Digital.

#### Notes:

- If the audio format of the digital output does not match the capabilities of your receiver, the receiver will produce a strong, distorted sound or no sound at all.
- Six Channel Digital Surround Sound via digital connection can only be obtained if your receiver is equipped with a Digital Multi-channel decoder.
- To see the audio format of the current disc in the on-screen display, press AUDIO.

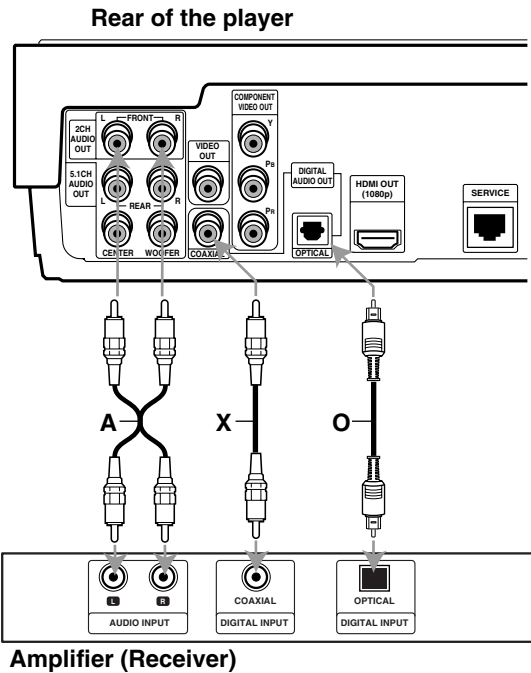

**Analog connection to a multi-channel A/V receiver with 6 Channel connectors (Dolby Digital, DTS):** This player contains a multi-channel decoder. This enables playback of discs recorded in Multi-channel Surround without the need for an optional decoder.

For this audio connection, set the [Speaker Out] option to [5.1CH] and make the appropriate [5.1 Speaker Setting] option on the setup menu. (See page 18.)

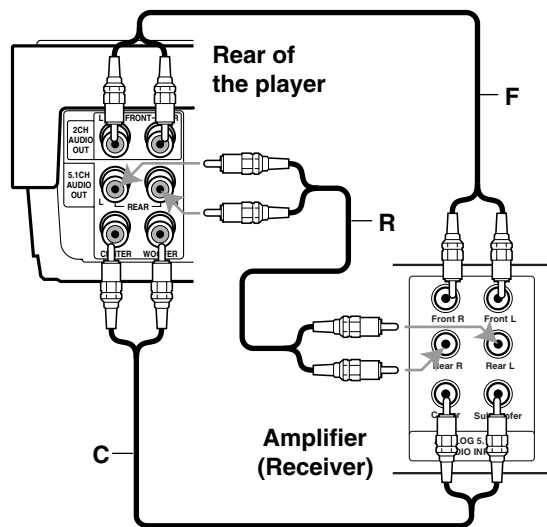

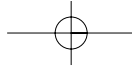

## Resolution Setting

The player provides several output resolutions for HDMI and COMPONENT VIDEO OUT jacks. You can change the resolution using SETUP menu or pressing the RESOLUTION button in complete stop mode.

**1080p** – Outputs 1080 lines of progressive video. (only for HDMI connection and BD-ROM/HD DVD discs recorded in 1080p)

**1080i** – Outputs 1080 lines of interlaced video.

**720p** – Outputs 720 lines of progressive video.

**576p** – Outputs 576 lines progressive video.

**576i** – Outputs 576 lines of interlaced video. (Only resolution available on VIDEO OUT, not available on HDMI connection)

### How to change the resolution using RESOLUTION button

Press RESOLUTION button on the Remote Control or front panel in complete stop mode.

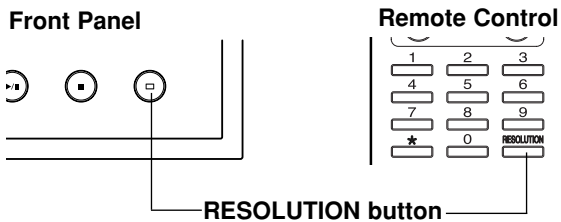

### How to change the resolution using Setup menu

1. Press SETUP in complete stop mode. The Setup menu appears.
2. Use ▲ / ▼ to select [Display] option then press ► to move to the second level.
3. Use ▲ / ▼ to select the [Resolution] option then press ► to move to the third level.



4. Use ▲ / ▼ to select the desired resolution then press ENTER to confirm your selection.

### Available resolution according to connection

#### HDMI connection

- BD-ROM / HD DVD playback: 1080p, 1080i, 720p and 576p are all available.
- DVD playback: 1080i, 720p and 576p are available.
- If the HDMI jack is connected for TVs providing display information (EDID), you can not select resolutions that the TV does not accept.
- If a title or disc is recorded in a resolution lower than 1080p, the output resolution is automatically changed to no higher than 1080i (even if 1080p is selected in the menu).
- 576i is not available.

#### COMPONENT VIDEO OUT connection

- BD-ROM / HD DVD / DVD playback: 1080i, 720p, 576p and 576i are available.
- The resolution may be limited depending on the title in BD-ROM and HD DVD.
- However, resolutions not supported by the TV are unavailable.
- If the disc is copy protected, the resolution will be changed to 576i automatically.

#### VIDEO OUT connection

- BD-ROM / HD DVD / DVD playback:  
The resolution of the VIDEO OUT jack is fixed to 576i.

#### Notes:

- Only resolutions supported by the TV are available.
- Depending on your TV, certain HDMI output resolutions may not work.
- If your TV does not accept your resolution setting, an abnormal picture appears on the screen. Please read TV's owner's manual then set the resolution that your TV can accept.

#### Note for 1080p resolution

The LG Super Multi Blue player is able to provide a 1080p full HD image to most 1080p-capable TVs in the market today. However, there are some 1080p TVs available from certain companies that are limited in the types of 1080p images that can be accepted. Specifically, 1080p-capable TVs that only accept images in 50/60Hz can display an image from this player in 1080i resolution.

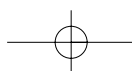

## Initial Settings

By using the Setup menu, you can make various adjustments to items such as picture and sound. You can also set a language for the subtitles and the Setup menu, among other things. For details on each Setup menu item, see pages 16 to 19.

### To display and exit the Menu:

Press **SETUP** to display the menu in complete stop mode. A second press of **SETUP** will take you back to initial screen.

### To go to the next level:

Press **▶** on the Remote Control.

### To go back to the previous level:

Press **◀** on the Remote Control.

## General Operation

1. Press **SETUP** in complete stop mode. The Setup menu appears.

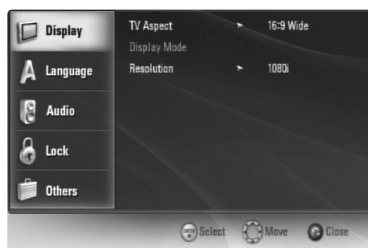

2. Use **▲ / ▼** to select the desired option then press **▶** to move to the second level. The screen shows the current setting for the selected item, as well as alternate setting(s).
3. Use **▲ / ▼** to select the second desired option then press **▶** to move to the third level.
4. Use **▲ / ▼** to select the desired setting then press **ENTER** to confirm your selection. Some items require additional steps.
5. Press **RETURN**, **SETUP**, or **PLAY** to exit the Setup menu.

## Display Menu



### TV Aspect

**4:3** – Select when a standard 4:3 TV is connected. (4:3 can be affected only when the resolution is 576i or 576p.)

**16:9** – Select when a 16:9 wide TV is connected.

### Display Mode

Display Mode setting is available only when the TV Aspect mode is set to [4:3].

**Letterbox** – Displays a wide picture with bands on the upper and lower portions of the screen.

**Pan Scan** – Automatically displays the wide picture on the entire screen and cuts off the portions that do not fit.

### Notes:

- Display Mode may not be supported on a HD DVD title.
- The Pan Scan option does not operate during BD-ROM playback.

### Resolution

Sets the output resolution of the Component and HDMI video signal.

The number in 576i, 576p, 720p, 1080p and 1080i indicates the number of lines of video. The “i” and “p” indicate interlaced and progressive scan, respectively.

**1080p** – Outputs 1080 lines of progressive video. (only for HDMI connection and BD-ROM/HD DVD discs recorded in 1080p)

**1080i** – Outputs 1080 lines of interlaced video.

**720p** – Outputs 720 lines of progressive video.

**576p** – Outputs 576 lines progressive video.

**576i** – Outputs 576 lines of interlaced video. (COMPONENT and VIDEO OUT jack only)

### Note:

Refer to “Resolution Setting” on page 15 for details about the resolution.

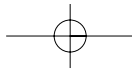

## Language Menu



### Display Menu Language

Select a language for the Setup menu and on-screen display.

### Disc Menu / Audio / Subtitle Language

Select the language you prefer for the audio track (disc audio), subtitles, and the disc menu.

**Original** – Refers to the original language in which the disc was recorded.

**Other** – To select another language, press number buttons then ENTER to enter the corresponding 4-digit number according to the language code list on page 26. If you make a mistake while entering a number, press CLEAR repeatedly to delete numbers one by one then correct it.

**Off (for Disc Subtitle)** – Turn off Subtitle.

## Audio Menu

Each DVD disc has a variety of audio output options. Set the player's Audio options according to the type of audio system you use.



### SPDIF (Digital Audio Output)

**Bitstream** – Select [Bitstream] if you connect this unit's DIGITAL OUT jack to an A/V Receiver or other equipment with a Dolby Digital, DTS or MPEG decoder.

**PCM (for Dolby Digital / MPEG / DTS)** – Select when connected to a two-channel digital stereo amplifier. DVDs encoded in Dolby Digital, DTS or MPEG will be automatically downmixed to two channel PCM audio.

### Notes:

- With digital audio connection, Disc Menu button sounds may not be heard if the [SPDIF] option is set to [Bitstream]. (BD-ROM)
- In Bitstream mode, this player does not support DTS-HD audio on some HD DVD and abnormal audio will output from audio out jack. To listen to the DTS-HD audio, you must set the [SPDIF] option to [PCM].
- On Bitstream mode, MPEG audio on DVD will output with PCM.

### Sampling Freq. (Frequency)

If your A/V Receiver or Amplifier is NOT capable of handling 96 kHz signals, select 48 kHz. When this choice is made, this unit automatically converts any 96 kHz signals to 48 kHz so your system can decode them.

If your A/V Receiver or Amplifier is capable of handling 96 kHz signals, select 96 kHz.

Check the documentation for your A/V Receiver or Amplifier to verify its capabilities.

### Speaker Out

To select various parameters for the analog 5.1 channel output.

**2CH** – When a 2 channel stereo system is connected to this player.

**5.1CH** – When a 5.1 channel surround system is connected to this player.

### 5.1 Speaker Setting

The 5.1 Speaker Setting option is only available when the [Speaker Out] option is set to [5.1CH]. Select speaker settings, including speaker size, or test the speaker settings. Speaker settings are only active on the Analog Multi-Channel Output. (See [5.1 Speaker Settings] on the next page.)

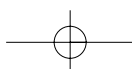

## 5.1 Speaker Setting

Make the following settings for the built-in 5.1 channel surround decoder.

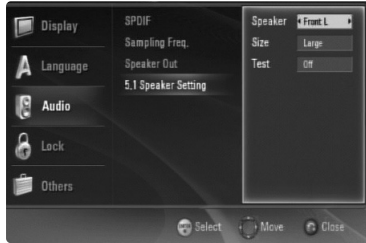

1. Press SETUP. The setup menu appears.
2. Use ▲ / ▼ to select the [Audio] option then press ► to move to the second level.
3. Use ▲ / ▼ to select the [5.1 Speaker Setting] option then press ► to move to the third level.
4. Use ◀ / ▶ to select the desired speaker.
5. Adjust options using ▲ / ▼ / ◀ / ▶ buttons.
6. Press ▲ / ▼ repeatedly to return to the previous menu screen.

### Speaker selection

Select a speaker that you want to adjust. (Front Left Speaker, Centre Speaker, Front Right Speaker, Rear Right Speaker, Rear Left Speaker, or Subwoofer.)

### Size

Press ◀ / ▶ to set a mode. (Large, Small or None)

If you have connected the system to a speaker with a low frequency of 100Hz or below, select [Large].

If you have connected the system to a speaker without a low frequency of 100Hz or below, select [Small]. If you have not connected a subwoofer, always select [Large] for Front speaker (L/R).

When you do not have a certain speaker connected, select [None].

Front L/R speaker's size can be set to [Large] or [Small].

If Front L/R speaker's size is set to [Small], Rear and Centre speaker's size can only be set to [Small] or [None].

Subwoofer's size can be set only to [Large] or [None]. Select [None] to disable the subwoofer speaker. (This option can only be selected when the Front (L+R) speakers are set to Large.)

### Test

Select [All] using ◀ / ▶ to test the signals of each speaker.

Front Left (L) → Centre → Front Right (R)  
→ Rear Right (R) → Rear Left (L) → Subwoofer

Adjust the volume during operation of the test tone on the Amplifier or A/V Receiver, so that all speaker's volumes are the same from the listener's position.

### Note:

If a speaker's sound is not heard, change the speaker's size setting.

## Lock Menu (Parental Control)



### Rating

Blocks playback of rated DVDs based on their content. (Not all discs are rated.)

1. Select [Rating] on the Lock menu then press ►.
2. To access the [Lock] options, you must input the password you have created. If you have not yet entered password, you will be prompted to do so. Input a password and press ENTER. Enter it again and press ENTER to verify. If you make a mistake before pressing ENTER, press CLEAR.
3. Select a rating from 1 to 8 using the ▲ / ▼ buttons.

**Rating 1-8:** Rating one (1) has the most restrictions and rating eight (8) is the least restrictive.

**Unlock:** If you select unlock, parental control is not active and the disc plays in full.

4. Press ENTER to confirm your rating selection, then press SETUP to exit the menu.

### Set Password

You can enter or change the password.

1. Select [Set Password] option on the Lock menu then press ►.
2. To create new password, press ENTER when the [New] option is highlighted. Input new password and press ENTER. Enter it again and press ENTER to verify.

To change the password, press ENTER when the [Change] option is highlighted, then input old password and press ENTER. Input new password and press ENTER. Enter it again and press ENTER to verify.

To delete the password, select [Delete] option then press ENTER, then input old password and press ENTER. The password is deleted.

3. Press SETUP to exit the menu.

### If you forget your password

If you forget your password, you can clear it using the following steps:

1. Remove any disc that might be in the player, or open the disc tray.
2. Press SETUP to display the Setup Menu and select the Lock Menu.
3. Press ENTER when the [Change] option is highlighted, then input the 6-digit number "210499" and press ENTER. Pressing the ◀ button to highlight the [Set Password] option will complete the password clearing process.

### Area Code

Enter the code of the area whose standards were used to rate the DVD video disc, based on the list on page 26.

1. Select [Area Code] on the Lock menu then press ►.
2. Follow step 2 as shown left (Rating).
3. Select the first character using ▲ / ▼ buttons.
4. Press ► and select the second character using ▲ / ▼ buttons.
5. Press ENTER to confirm your Area code selection.

### Others Menu



### Button Sound

You can hear beep sound when you press a button on the front panel. Set [ON] for this effect.

### Java Application Font Size **BD**

You can adjust the default text size displayed for the JAVA contents during BD-ROM playback. This setting is only valid when the JAVA contents do not set the size of text. Please select a font size bigger than 24 when the player is connected with an HD TV.

# Operations

## General playback features

1. Load your chosen disc in the tray, with the playback side down.
2. Playback starts.

Buttons	Operations
■ (STOP)	Stops the playback. The unit records the stopped point, depending on the disc. "■■■" appears on the screen briefly. Press PLAY (▶) to resume playback (from the scene point). If you press STOP (■) again or unload the disc ("■" appears on the screen.), the unit will clear the stopped point. <b>(■■■ = Resume Stop, ■ = Complete Stop)</b> <b>Note:</b> The resume point may be cleared when a button is pressed (for example; POWER, OPEN/CLOSE, etc).
OPEN / CLOSE (▲)	Opens or closes the disc tray.
(PAUSE)	During playback, press    to pause playback. Press    repeatedly to play Frame-by-Frame.
◀◀ / ▶▶ (SKIP)	During playback, press SKIP (◀◀ or ▶▶) to go to the next chapter or to return to the beginning of the current chapter. Press SKIP ◀◀ twice briefly to step back to the previous chapter.
◀◀ / ▶▶ (SCAN)	During playback, press SCAN (◀◀ or ▶▶) repeatedly to select the required scan speed. (5 steps) While the playback is paused, press SCAN ▶▶ repeatedly to play in slow motion (4 steps, forward only).
REPEAT	During playback, press REPEAT repeatedly to select a desired repeat mode. (Chapter/Title/Off)
A-B	During playback, each press of A-B button to select point A and point B and repeats a sequence from point A (Starting point) to point B (End point). To cancel the sequence, press A-B.
TITLE <b>DVD</b> <b>HD DVD</b>	If the current DVD and HD DVD disc has a menu, the Title menu appears on the screen. Depending on the disc, the Title Menu may not be available. In this case, the disc menu may appears. (For the HD DVD advanced content title with HDi features, the menu that is supplied by this player is displayed.)
POP UP <b>BD</b>	If the current BD-ROM disc has a menu, the Popup menu appears on the screen. Depending on the disc, the Popup Menu may not be available.
DISC MENU <b>DVD</b> <b>HD DVD</b>	The menu appears on the screen. (For the HD DVD advanced content title with HDi features, the menu that is supplied by this player is displayed.)
<b>BD</b>	The top menu appears on the TV screen.
ANGLE (📷)	During playback of the disc contains scenes recorded different camera angles, press ANGLE repeatedly to select a desired angle.
SUBTITLE (🗨)	During playback, press SUBTITLE repeatedly to select a desired subtitle language.
AUDIO (🔊)	During playback, press AUDIO repeatedly to hear a different audio language or audio track.

### Notes on general features:

- If you press SKIP (▶▶) once during Repeat Chapter playback, the repeat playback cancels.
- When you are playing a disc containing scenes recorded different camera angles, the angle indicator will appear on the TV screen for a while and display window during scenes recorded at different angles as an indication that angle switching is possible.
- The REPEAT or A-B button may not work on some discs.

## If a disc menu screen is displayed

The menu screen may be displayed first after loading a disc which contains a menu.

Use the ◀ / ▶ / ▲ / ▼ buttons to select the title/chapter you want to view, then press ENTER to start playback.

## Time Search

To start playing at any chosen time on the disc:

1. Press DISPLAY during playback.
2. Press ▲ / ▼ to select the time clock icon and "--:--:--" appears.
3. Input the required start time in hours, minutes, and seconds from left to right. If you enter the wrong numbers, press CLEAR to remove the numbers you entered. Then input the correct numbers.
4. Press ENTER to confirm. Playback starts from the selected time.

### Note:

This function may not work on some disc or titles.

## Marker Search

### To enter a Marker

You can start playback from up to nine memorized points. To enter a marker, press MARKER at the desired point on the disc. The Marker icon appears on the TV screen briefly. Repeat to enter up to nine markers.

### To Recall or Clear a Marked Scene

1. During disc playback, press SEARCH. The marker search menu appears on the screen.
2. Within 10 seconds, press ◀ / ▶ to select a marker number that you want to recall or clear.
3. Press ENTER and playback starts from the marked scene. Or, Press CLEAR and the marker number is erased from the list.
4. You can play any marker by inputting its number on the marker search menu.

### Notes:

- This function may not work on some disc or titles.
- All marked points are cleared if you press STOP (■) twice or unload the disc. (complete stop).

## Using Colour Buttons **BD**

These buttons are available only during BD-ROM's JAVA content playback. Use appropriate colour button as indicated by the JAVA display during BD-ROM disc playback. Depending on the disc contents, the functions of each button may differ.

## Screen Saver

The screen saver appears when you leave the player in Stop mode for about five minutes.

## Displaying Disc Information On-Screen

You can display various information about the disc loaded on-screen.

1. Press DISPLAY to show various playback information.

The items displayed differ depending on the disc type or playing status.



2. During playback, you can select an item by pressing ▲ / ▼ and change or select the setting by pressing ◀ / ▶.
  - Title – Current title number/total number of titles.
  - Chapter – Current chapter number/total number of chapters.
  - Time – Elapsed playing time.
  - Audio – Selected audio language or channel.
  - Subtitle – Selected subtitle.
  - Angle – Selected angle/total number of angles.

### Notes:

- If no button is pressed for a few seconds, the on-screen display disappears.
- A title number cannot be selected on some discs.
- An item may not be available on some discs or titles.

## Special Features for HD DVD

### HD DVD Twin Format Discs **HD DVD**

If you insert an HD DVD Twin Format Disc with both HD DVD and DVD layers on one side, you must select HD DVD or DVD to start playback.

1. Insert an HD DVD Twin Format Disc.  
The choice menu will appear.
2. Select HD DVD or DVD on the menu then press ENTER. The selected playback format begins.

#### Notes:

- You cannot change the format during playback.
- To change the format, press OPEN/CLOSE to open the disc tray then close the disc tray.
- You can only use POWER, ◀ / ▶, and ENTER buttons when the choice menu is displayed.

### Using the HD DVD with HDi features

#### HD DVD

You can change title number, scene number, etc using the HD DVD menu.

1. Press DISC MENU or TITLE during HD DVD playback.  
The menu will appear.

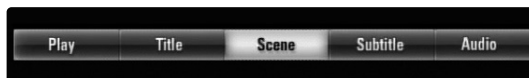

#### Note:

The above HD DVD menu is displayed only when an HD DVD disc with HDi features is playing.

2. Use the ◀ / ▶ buttons to select an option, then press ENTER.  
The sub options will appear.

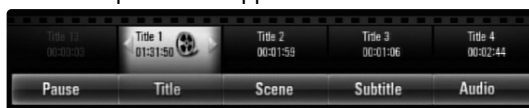

- Play / Pause – Starts playback / pauses playback.
  - Title – Selects a title on a disc.  
You cannot select a title whose number is shown a gray colour because the title is recorded with black by contents providers. It is normal.
  - Scene – Selects a scene in a title.
  - Subtitle – Selects a subtitle language.
  - Audio – Selects an audio language, for playback only.
3. Use the ◀ / ▶ buttons to select a sub option, then press ENTER to acknowledge the selection.

### Multi Title List function **HD DVD**

Some HD DVD with HDi features has several Title Lists. In this case, you can select one of the Title Lists using [More Title List] option in the HD DVD menu.

1. Press DISC MENU or TITLE during HD DVD playback.  
The HD DVD menu will appear.
2. Use ◀ / ▶ buttons to select [Title] option then press ENTER.
3. Use ◀ / ▶ to select [More Title List] option then press ENTER.

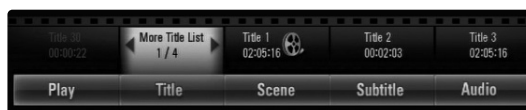

4. Select a Title List then press ENTER.

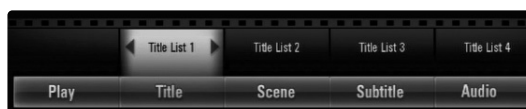

The playback starts from the beginning of the selected Title List.

## Special Features for BD-ROM

### BD Hybrid Discs **BD**

If you insert an BD Hybrid Discs having both BD and DVD layers on one side, you must select BD or DVD to start playback.

1. Insert a BD Hybrid Disc.  
The choice menu will appear.
2. Select BD or DVD on the menu then press ENTER. The selected playback format begins.

#### Notes:

- You cannot change the format during playback.
- To change the format, press OPEN/CLOSE to open the disc tray then close the disc tray.
- You can only use POWER, ◀ / ▶, and ENTER buttons when the choice menu is displayed.

# Reference

## Controlling an LG TV with the Supplied Universal Remote Control

You can control the volume, input source, and power state of your LG TV with the supplied Universal Remote Control.

You can control your TV using the buttons below.

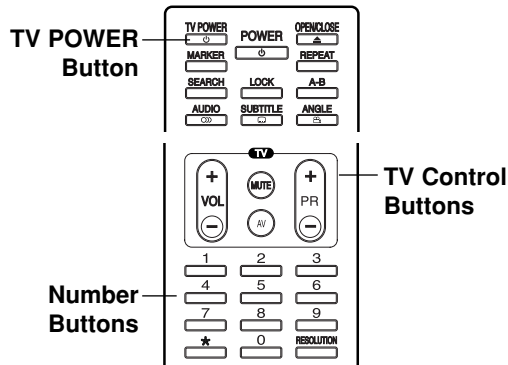

## Controlling other TVs with the Universal Remote Control

You can control the volume, input source, and power state of non-LG TVs as well. If your TV is listed in the table on the next page, set the appropriate manufacturer code.

1. While holding down TV POWER button, press the number buttons to select the manufacturer code for your TV (Refer to table on the next page).
2. Release TV POWER button.

### Notes:

- Depending on your TV, some or all buttons may not function on the TV, even after entering the correct manufacturer code.
- If you enter a new code number, the code number previously entered will be erased.
- When you replace the batteries of the remote, the code number you have set may be reset to the default setting. Set the appropriate code number again.

By pressing	You can
TV POWER	Turn the TV on or off.
AV	Switch the TV's input source between the TV and other input sources.
PR +/-	Scan up or down through memorized channels.
VOL +/-	Adjust the volume of the TV.
MUTE	Temporarily turns TV sound OFF, press again to restore.

### Note:

Depending on the unit being connected, you may not be able to control your TV using some of the buttons.

## Code numbers of controllable TVs

If more than one code number is listed, try entering them one at a time until you find the one that works with your TV.

BRANDS	CODES	BRANDS	CODES	BRANDS	CODES
ADMIRAL	137 204	ELBE	058 144 157 160	HITACHI	011 013 015 017
ADYSON	159 219		192 246		021 022 023 024
AKAI	009 010 108 132	ELBIT	108 248		028 029 030 035
	133 135 139 140	ELECTROVENDA	108		039 040 041 048
	156 174 175	ELEKTRONIKA	108		053 054 055 056
AKURA	064 086 108 110	ELIN	108		057 120 127 128
	155 171	ELITE	064 149		129 134 135 140
ALBA	009 060 064	ELMAN	144		143 145 147 151
ALLSTAR	108	ELTA	010 171		156 159 173 193
AMSTRAD	006 025 157	EMERSON	108 204		219
AMWAY	108	ESC	108	HYPER	009 159 163 171
ANITECH	010 049 108 185	ETRON	133	ICE	009 010 064 108
	219	EUROPHON	144 159		171
ANTECNO	064	EXPERT	089	IMPERIAL	043 049 108 139
ARC EN CIEL	173 179 239	FENNER	171		144 154 165 255
ASA	087 102 108 235	FERGUSON	078 079 080 160	INGERSOLL	171
	236		182 195 198 199	INNO HIT	159 189 237
ASBERG	185		200 201 202	INTERBUY	010
ASORA	171	FINLANDIA	194 195	INTERCORD	233
ATLANTIC	089 197	FINLUX	008 087 102 104	INTERFUNK	108 109 113 130
AUDIOSONIC	085		105 107 108 140		133 134 135 137
AUTOVOX	159 163 197		144 159 161 174		141 146 147 148
BANK	232		189 235 236		165 179 210
BEKO	045 085 086 108	FIRST-LINE	144	INTERVISION	010 086 108 132
	250	FISHER	086 208 222 233		144 166
BESTAR	086	FORMENTI	108 149	IRRADIO	163 235 237
BLAUPUNKT	031 091 092 096	FRABA	108	ITC	144 159
	097 098 099 210	FRONTECH	136 171 220	ITS	009 010 064 171
	253	FUBA	073 109	ITT	141 151 186
BONDSTEC	163	FUJITSU GENERAL	088 159 197	JVC	009 169
BOSCH	210	FUNAI	010	KAIDO	136
BRANDT	173 179 225 239	GALAXIS	108 185	KAPSCH	089 147 148 197
ELECTRONIQUE		GALERIA	171	KARCHER	084 108
BRIONVEGA	204	GBC	137 144 171	KATHREIN	109
BSR	144	GEC	011 108 129 147	KAWA	009
BUSH	009 136 139 144		159 189	KENDO	060 108 137 157
	232	GELOSO	064 137 144 164	KENNEDY	197
CENTURY	165 204		171	KNEISSEL	108
CGE	139 165 210	GENERAL	171	KONKA	009
CIE	025 108 170	GENERAL TECHNIC	171	KORTING	086 204 209
CLATRONIC	009 010 064 108	GOLDHAND	159 171	KUBA	233
	144 149 159 164	GOLDSTAR	038 050 108 110	KUBA ELECTRONIC	233
	165 171 185		136 144 159 163	KURA	134
CLARIVOX	033		166 171 191 219	LENCO	108 170
CONDOR	108 149 191		237	LG	001(Default) 038
CONIC	219	GOODMANS	009 064 108 109		050 108 110 136
CONTEC	171 222		110 120 159 170		144 159 163 166
CONTINENTAL	173 179 225 239		171		171 191 219 237
EDISON		GORENJE	086	LIESENKOTTER	108 210
COSMOS	108	GPM	010 064	LIFETEC	010 064 108 170
CROSLEY	165 204	GRANADA	027 105 108 111	LOEWE	109 113 204 205
CROWN	084 085 086 108		121 134 140 159	LOGIK	070 227
	144 171 185		162 167 187 194	LUMA	137 197
CS-ELECTRONICS	064		195 238	LUXOR	102 104 132 133
DAEWOO	051 108 120 127	GRUNDIG	091 092 093 094		134 135 138 140
	170		095 097 098 100		143 145 153 156
DANSAI	010 219		101 172 232 238		174 186 237
DE GRAAF	108 134	HCM	010 108 159 171	M ELECTRONIC	103 104
DECCA	070 108 159 161	HIFIVOX	173 179 239	MAGNADYNE	163 164 204
	162 184 189 190	HINARI	010 064 108 133	MAGNAFON	199
	206		171	MAGNASONIC	108
DECCAVIDEO	108	HIT	204	MARANTZ	108
DUAL	233			MARSHAL	064
DUMONT	204			MATSUI	009 016 025 060
					061 062 063 070
					108 131 136 152
					154 159 171 172

BRANDS	CODES
MERRIT	132
METZ	047 092 097 098 100 101 108 204 207 254
MITSUBISHI	075 076 077 097 113 204 222 224 240
MIVAR	044 042 159 235
MNARTT	007
MTC	086 109 134
MULTITECH	136 159 171 185
MURPHY	232
NAONIS	137
NECKERMANN	037 059 060 092 098 100 101 108 109 113 115 118 119 134 135 137 143 157 159
NEI	064 108
NIKKAI	219
NIKKO	108
NOBLIKO	232 235
NOGAMATIC	173 179 239
NOKIA	014 019 032 102 103 104 108 132 133 134 135 138 140 141 145 146 147 148 156 174
NORDMENDE	129 173 179 180 181 193 195 225 226 228 239
NORMN	108
NOVA	087
OCEANIC	032 103 104 135 140 156
OKANO	108
ONWA	009 010 064
ORAVA	108
ORBITER	086
ORION	025 059 060 061 062 064 070 108 110 118 219
OSAKE	106
OTTO-VERSAND	002 005 009 014 059 060 081 082 083 085 092 097 098 100 101 108 109 111 113
PAEL	235
PANASONIC	002 003 005 167 168 229
PATHE CINEMA	144
PATHE MARCONI	173 179 225 239
PHILCO	090 108 139 144 148 165 204
PHILIPS	065 066 067 068 069 092 108 109 111 112 114 115 116 119 122 123 124 125 193 212 251 252
PIONEER	193
PRANDONI-PRINCE	137 235
PRIMA	219
PRO VISION	108

BRANDS	CODES
PROFEX	108 136 171
PROFITRONIC	108
QUELLE	002 010 014 019 025 059 060 072 084 086 087 088 092 097 098 100 101 102 175
RADIOLA	108
RADIOTONE	010 085 108 171
REDIFUSSION	187
REVOX	109
REX	088 089 137 157 158 164 197 246 247
RFT	064 085 135 204
RITAR	138
ROADSTAR	108
ROSITA	171
SABA	079 146 147 173 179 181 193 195 225 226 239
SAISHO	025 060 070 136 159
SAKIO	171
SALORA	019 032 103 104 132 133 134 135 137 138 140 142 143 145 150 156 174 237 241
SAMBERS	235
SAMSUNG	004 010 050 086 108 117 126 171 220 237
SANY	193
SANYO	014 018 019 020 032 034 071 086 087 189 218 221 222 223
SCHNEIDER	009 064 088 108 133 141 159 163 233
SEG	010 064 108 144 159 165 171 185 219
SEI-SINUDYNE	025 108 204 212
SELECO	088 089 137 157 197 222
SENTRA	064 133
SHARP	081 082 083 222
SHINTOM	108
SHINTOSHI	108
SHIVAKI	108
SIAREM	204
SIEMENS	092 096 097 098 100 101 108 210 218 219 221
SIESTA	085
SILVER	010 064
SINGER	108 164 204
SINUDYNE	118 131
SMARAGO	172
SOLAVOX	133
SONOLOR	140 156
SONTEC	108
SONY	072 074 211 212 213 214 215 216 217 222

BRANDS	CODES
SPECTRA	170
STARLITE	108 171
STARLUX	171
STERN	088 089 137 157 197
SUNSTAR	108 171
SUPERTECH	108 139 152 171
TADISTAR	108
TASHIKO	108 159 218
TEC	108 139 144 159 170 171
TECHLINE	185
TECHNISAT	108 165
TECNISON	108 171
TEKON	171
TELEAVIA	173 178 179 225 239
TELEFUNKEN	079 177 179 181 193 195 200 210
TELEOPTA	171
TELERNT	109
TELETECH	165 171
TELETEXT	115
TELETON	088
TELETON	089 134 159 197
TENSAI	064 108 144 149 171 191
TENSON	171
TESLA	204
THOMSON	052 078 079 134 173 178 179 181 193 195 225 239
THORN	011 014 016 018 026 028 066 072 075 087 097 102 108 116 135 141 145 146 160
THORN-FERGUSON	160 188 200 227
TOSHIBA	012 016 026 036 037 222 232
TOWADA	144 185
TRISTAR	010 064
TRIUMPH	025 219 236
UHER 089	108 109 149 185 197 233
ULTRAVOX	108 164 185 204
UNIVERSUM	174
UNIVOX	204
VESTEL	108
VIDEOSAT	165
VIDEOTON	178 193
VIDEOWAY	230
VISION	108 149
VOXSON	137 204
WALTHAM	178
WATSON	064 108 149 171
WEGA	208 222
WHITE	108 110 149
WESTINGHOUSE	
YOKO	010 064 108 136 144 159 164 170 171
ZANUSSI	137 197
ZENITH	231

## Language Codes

Use this list to input your desired language for the following initial settings:  
Disc Audio, Disc Subtitle, Disc Menu.

Language	Code	Language	Code	Language	Code	Language	Code
Abkhazian	6566	Fiji	7074	Lingala	7678	Singhalese	8373
Afar	6565	Finnish	7073	Lithuanian	7684	Slovak	8375
Afrikaans	6570	French	7082	Macedonian	7775	Slovenian	8376
Albanian	8381	Frisian	7089	Malagasy	7771	Somali	8379
Ameharic	6577	Galician	7176	Malay	7783	Spanish	6983
Arabic	6582	Georgian	7565	Malayalam	7776	Sudanese	8385
Armenian	7289	German	6869	Maltese	7784	Swahili	8387
Assamese	6583	Greek	6976	Maori	7773	Swedish	8386
Aymara	6589	Greenlandic	7576	Marathi	7782	Tagalog	8476
Azerbaijani	6590	Guarani	7178	Moldavian	7779	Tajik	8471
Bashkir	6665	Gujarati	7185	Mongolian	7778	Tamil	8465
Basque	6985	Hausa	7265	Nauru	7865	Tatar	8484
Bengali; Bangla	6678	Hebrew	7387	Nepali	7869	Telugu	8469
Bhutani	6890	Hindi	7273	Norwegian	7879	Thai	8472
Bihari	6672	Hungarian	7285	Oriya	7982	Tibetan	6679
Breton	6682	Icelandic	7383	Panjabi	8065	Tigrinya	8473
Bulgarian	6671	Indonesian	7378	Pashto, Pushto	8083	Tonga	8479
Burmese	7789	Interlingua	7365	Persian	7065	Turkish	8482
Byelorussian	6669	Irish	7165	Polish	8076	Turkmen	8475
Cambodian	7577	Italian	7384	Portuguese	8084	Twi	8487
Catalan	6765	Japanese	7465	Quechua	8185	Ukrainian	8575
Chinese	9072	Javanese	7487	Rhaeto-Romance	8277	Urdu	8582
Corsican	6779	Kannada	7578	Rumanian	8279	Uzbek	8590
Croatian	7282	Kashmiri	7583	Russian	8285	Vietnamese	8673
Czech	6783	Kazakh	7575	Samoan	8377	Volapük	8679
Danish	6865	Kirghiz	7589	Sanskrit	8365	Welsh	6789
Dutch	7876	Korean	7579	Scots Gaelic	7168	Wolof	8779
English	6978	Kurdish	7585	Serbian	8382	Xhosa	8872
Esperanto	6979	Laothian	7679	Serbo-Croatian	8372	Yiddish	7473
Estonian	6984	Latin	7665	Shona	8378	Yoruba	8979
Faroese	7079	Latvian, Lettish	7686	Sindhi	8368	Zulu	9085

## Area Codes

Choose an Area code from this list.

Area	Code	Area	Code	Area	Code	Area	Code
Afghanistan	AF	Ethiopia	ET	Malaysia	MY	Saudi Arabia	SA
Argentina	AR	Fiji	FJ	Maldives	MV	Senegal	SN
Australia	AU	Finland	FI	Mexico	MX	Singapore	SG
Austria	AT	France	FR	Monaco	MC	Slovak Republic	SK
Belgium	BE	Germany	DE	Mongolia	MN	Slovenia	SI
Bhutan	BT	Great Britain	GB	Morocco	MA	South Africa	ZA
Bolivia	BO	Greece	GR	Nepal	NP	South Korea	KR
Brazil	BR	Greenland	GL	Netherlands	NL	Spain	ES
Cambodia	KH	Herd and McDonald Islands	HM	Netherlands Antilles	AN	Sri Lanka	LK
Canada	CA	Hong Kong	HK	New Zealand	NZ	Sweden	SE
Chile	CL	Hungary	HU	Nigeria	NG	Switzerland	CH
China	CN	India	IN	Norway	NO	Taiwan	TW
Colombia	CO	Indonesia	ID	Oman	OM	Thailand	TH
Congo	CG	Israel	IL	Pakistan	PK	Turkey	TR
Costa Rica	CR	Italy	IT	Panama	PA	Uganda	UG
Croatia	HR	Jamaica	JM	Paraguay	PY	Ukraine	UA
Czech Republic	CZ	Japan	JP	Philippines	PH	United States	US
Denmark	DK	Kenya	KE	Poland	PL	Uruguay	UY
Ecuador	EC	Kuwait	KW	Portugal	PT	Uzbekistan	UZ
Egypt	EG	Libya	LY	Romania	RO	Vietnam	VN
El Salvador	SV	Luxembourg	LU	Russian Federation	RU	Zimbabwe	ZW

## Troubleshooting

Symptom	Possible Cause	Correction
No power.	<ul style="list-style-type: none"> <li>The power cord is disconnected.</li> </ul>	<ul style="list-style-type: none"> <li>Plug the power cord into the wall outlet securely.</li> </ul>
The power is on, but the player does not work.	<ul style="list-style-type: none"> <li>No disc is inserted.</li> </ul>	<ul style="list-style-type: none"> <li>Insert a disc. (Check the disc indicator in the display window is lit.)</li> </ul>
No picture.	<ul style="list-style-type: none"> <li>The TV is not set to receive DVD signal output.</li> </ul>	<ul style="list-style-type: none"> <li>Select the appropriate video input mode on the TV.</li> </ul>
	<ul style="list-style-type: none"> <li>The video cable is not connected securely.</li> </ul>	<ul style="list-style-type: none"> <li>Connect the video cable securely.</li> </ul>
	<ul style="list-style-type: none"> <li>The selected resolution is not capable with your TV.</li> </ul>	<ul style="list-style-type: none"> <li>Select another resolution using RESOLUTION button.</li> </ul>
No sound.	<ul style="list-style-type: none"> <li>The equipment connected with the audio cable is not set to receive disc signal output.</li> </ul>	<ul style="list-style-type: none"> <li>Select the correct input mode of the audio receiver so you can listen to the sound from the player.</li> </ul>
	<ul style="list-style-type: none"> <li>The power of the equipment connected with the audio cable is turned off.</li> </ul>	<ul style="list-style-type: none"> <li>Turn on the equipment connected with the audio cable.</li> </ul>
	<ul style="list-style-type: none"> <li>The [Audio] options are set to the wrong position.</li> </ul>	<ul style="list-style-type: none"> <li>Set the [Audio] options to the correct position, then turn on the player again by pressing POWER.</li> </ul>
The player does not start playback.	<ul style="list-style-type: none"> <li>An unplayable disc is inserted.</li> </ul>	<ul style="list-style-type: none"> <li>Insert a playable disc. (Check the disc type and regional code.)</li> </ul>
	<ul style="list-style-type: none"> <li>The rating level is set.</li> </ul>	<ul style="list-style-type: none"> <li>Change the rating level.</li> </ul>
The Remote Control does not work properly.	<ul style="list-style-type: none"> <li>The Remote Control is not pointed at the remote sensor on the player.</li> </ul>	<ul style="list-style-type: none"> <li>Point the Remote Control at the remote sensor of the player.</li> </ul>
	<ul style="list-style-type: none"> <li>The Remote Control is too far from the player.</li> </ul>	<ul style="list-style-type: none"> <li>Operate the Remote Control closer to the player.</li> </ul>

## Maintenance and Service

Refer to the information in this chapter before contacting a service technician.

### Handling the Unit

#### When shipping the unit

Please save the original shipping carton and packing materials. If you need to ship the unit, for maximum protection, re-pack the unit as it was originally packed at the factory.

#### Keeping the exterior surfaces clean

Use the supplied cloth for cleaning the surfaces of the player.

- Do not use volatile liquids such as insecticide spray near the unit.
- Wiping with strong pressure may damage the surface.
- Do not leave rubber or plastic products in contact with the unit for a long period of time, since they could mark the surface.

### Cleaning the unit

To clean the player, use a soft, dry cloth. If the surfaces are extremely dirty, use a soft cloth lightly moistened with a mild detergent solution.

Do not use strong solvents such as alcohol, benzene, or thinner, as these might damage the surface of the unit.

### Maintaining the Unit

The unit is a high-tech, precision device. If the optical pick-up lens and disc drive parts are dirty or worn, the picture quality could be diminished.

Depending on the operating environment, regular inspection and maintenance are recommended after every 1,000 hours of use.

For details, please contact your nearest authorized service centre.

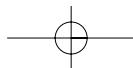

## Specifications

### General

<b>Power requirements:</b>	AC 200-240V, 50/60Hz
<b>Power consumption:</b>	30W
<b>Dimensions (W x H x D):</b>	Approx. 17 x 3.1 x 9.9 inches (430 x 79 x 250 mm) without feet
<b>Weight (Approx.):</b>	4.1 kg (9.1 lbs)
<b>Operating temperature:</b>	41 °F to 95 °F (5 °C to 35 °C)
<b>Operating humidity:</b>	5 % to 90 %

### Outputs

<b>VIDEO OUT:</b>	1.0 V (p-p), 75 $\Omega$ , sync negative, RCA jack x 1
<b>COMPONENT VIDEO OUT:</b>	(Y) 1.0 V (p-p), 75 $\Omega$ , negative sync, RCA jack x 1 (Pb)/(Pr) 0.7 V (p-p), 75 $\Omega$ , RCA jack x 2
<b>HDMI OUT (video/audio):</b>	19 pin (HDMI standard, Type A)
<b>ANALOG AUDIO OUT:</b>	2CH: 2.0 Vrms (1 KHz, 0 dB), 600 $\Omega$ , RCA jack (L, R) x 1 6CH: 2.0 Vrms (1 KHz, 0 dB), 600 $\Omega$ , RCA jack x 6
<b>DIGITAL OUT (COAXIAL):</b>	0.5 V (p-p), 75 $\Omega$ , RCA jack x 1
<b>DIGITAL OUT (OPTICAL):</b>	3 V (p-p), Optical jack x 1

### System

<b>Laser:</b>	Semiconductor laser, wavelength: 405nm / 650 nm
<b>Signal system:</b>	Standard PAL/NTSC Colour TV system
<b>Frequency response:</b>	8 Hz to 44 kHz (96 kHz Sampling) 8 Hz to 22 kHz (48 kHz Sampling)
<b>Signal-to-noise ratio:</b>	More than 100 dB (ANALOG OUT connectors only)
<b>Harmonic distortion:</b>	Less than 0.008%
<b>Dynamic range:</b>	More than 95 dB
<b>Accessories:</b>	Component Video cable (1) Video cable (1) Audio cable (1) Remote control (1) Batteries (2) Cloth for cleaning the surfaces of the player (1)

**Note:** Design and specifications are subject to change without prior notice.

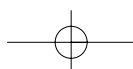

## Super Multi Blue Player's Audio Output Specifications

Disc/format		Setting		Analog Output		Digital (SPDIF/HDMI)	
				2ch	5.1ch	PCM	Bitstream*1
BD-ROM	Dolby Digital			2ch	5.1ch	2ch PCM	Dolby Digital
	Dolby Digital Plus			2ch	5.1ch	2ch PCM	Dolby Digital 5.1*2
	Dolby TrueHD			2ch	5.1ch	2ch PCM	Dolby Digital 5.1*3
	DTS			2ch	5.1ch	2ch PCM	DTS
	DTS-HD			2ch	5.1ch	2ch PCM	DTS*4
	Linear PCM 2ch			2ch	2ch	2ch PCM	2ch PCM
	Linear PCM 5.1ch			2ch	5.1ch	2ch PCM	2ch PCM
	Linear PCM 7.1ch			2ch	5.1ch	2ch PCM	2ch PCM
HD DVD	Dolby Digital			2ch	5.1ch	2ch PCM	Dolby Digital
	Dolby Digital Plus			2ch	5.1ch	2ch PCM	Dolby Digital 5.1*2
	Dolby TrueHD			2ch	2ch	2ch PCM	2ch PCM
	DTS			2ch	5.1ch	2ch PCM	DTS
	DTS-HD			2ch	5.1ch	2ch PCM	DTS*4
	Linear PCM 2ch			2ch	2ch	2ch PCM	2ch PCM
	Linear PCM 5.1ch			2ch	5.1ch	2ch PCM	2ch PCM
	Linear PCM 7.1ch			2ch	5.1ch	2ch PCM	2ch PCM
DVD Video	Dolby Digital			2ch	5.1ch	2ch PCM	Dolby Digital
	DTS			2ch	5.1ch	2ch PCM	DTS
	Linear PCM			2ch	2ch*5	2ch PCM	2ch PCM
	MPEG			2ch	2ch	2ch PCM	2ch PCM

\*1: In case of Bitstream mode, interactive and secondary audio is not included in the output bitstream. (Primary Audio Stream only)

\*2: DD+5.1ch core stream only

\*3: **Dolby Digital 5.1 substream only**

\*4: DTS-HD 5.1ch core stream only

\*5: In case of the source audio of 5.1 or 7.1 channels, the specification of output audio channels is 5.1.

### Notes:

- Some discs allow you to change audio selections only via the disc menu. If this is the case, press POP UP or DISC MENU button and choose the appropriate language from the selections on the disc menu.
- When you turn on the player or replace a disc, the player returns to the initial default setting. Depending on a disc, a specific type of audio the disc has is output.
- Immediately after you have switched sounds, there may be a temporary discrepancy between the display and actual sound.

## Open source software notice

The following GPL executables and LGPL/MPL libraries used in this product are subject to the GPL/LGPL/MPL License Agreements:

### GPL EXECUTABLES:

Linux kernel 2.4.25  
Busybox  
Bash  
e2fsprogs

### LGPL LIBRARIES:

libuClibc.so  
libstdc++.so  
libdirectfb.so  
libavcodec.so  
libavformat.so  
libiconv.so  
libgcrypt.so  
libgnutls.so  
libpgg-error.so

### MPL LIBRARIES:

libcairo.so

LG Electronics offers to provide source code to you on CD-ROM for a charge covering the cost of performing such distribution, such as the cost of media, shipping and handling upon e-mail request to LG Electronics at: [smbp\\_opensource@lge.com](mailto:smbp_opensource@lge.com)

This offer is valid for a period of three(3) years from the date of the distribution of this product by LG Electronics.

You can obtain a copy of the GPL, LGPL and MPL licenses from <http://us.lge.com>.

Portions of this software are copyright ©2003 The FreeType Project ([www.freetype.org](http://www.freetype.org)). All rights reserved.

The module, libjpeg.so used in this product is the work of the Independent JPEG Group.

© copyright 1991-1998, Thomas G. Lane. All rights reserved.

This product includes software developed by the University of California, Berkeley and its contributors.

## Customer Support

To obtain the latest software for this player (if updates have been made), please visit <http://au.lgservice.com>.

### Resetting the Player

If you observe any of the following symptoms...

- When the Player is plugged in, but the power will not turn on or off.
- When the display window is not working.
- When the Player does not operate normally.

You can reset the Player as follows:

- Press and hold the POWER button for more than five seconds. This will force the Player to power off. Press the POWER button again to turn the Player back on.
- Unplug the power cord and then plug the power cord again after more than five seconds.

