



Super Blu Player Owner's Manual

Model: BH200



Before connecting, operating or adjusting this product,
please read this instruction booklet carefully and completely.



CAUTION: TO REDUCE THE RISK OF ELECTRIC SHOCK DO NOT REMOVE COVER (OR BACK) NO USER-SERVICEABLE PARTS INSIDE REFER SERVICING TO QUALIFIED SERVICE PERSONNEL.



This lightning flash with arrowhead symbol within an equilateral triangle is intended to alert the user to the presence of uninsulated dangerous voltage within the product's enclosure that may be of sufficient magnitude to constitute a risk of electric shock to persons.



The exclamation point within an equilateral triangle is intended to alert the user to the presence of important operating and maintenance (servicing) instructions in the literature accompanying the product.

WARNING: TO PREVENT FIRE OR ELECTRIC SHOCK HAZARD, DO NOT EXPOSE THIS PRODUCT TO RAIN OR MOISTURE.

WARNING: Do not install this equipment in a confined space such as a book case or similar unit.

CAUTION:

Do not block any ventilation openings. Install in accordance with the manufacturer's instructions.

Slots and openings in the cabinet are provided for ventilation and to ensure reliable operation of the product and to protect it from over heating.

The openings should never be blocked by placing the product on a bed, sofa, rug or other similar surface. This product should not be placed in a built-in installation such as a bookcase or rack unless proper ventilation is provided or the manufacturer's instruction have been adhered to.

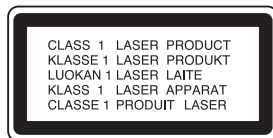

CAUTION:

This product employs a Laser System. To ensure proper use of this product, please read this owner's manual carefully and retain it for future reference. Should the unit require maintenance, contact an authorized service center.

Use of any controls, adjustments, or procedures other than those specified herein may result in hazardous radiation exposure.

To prevent direct exposure to laser beam, do not try to open the enclosure. Visible laser radiation when open. DO NOT STARE INTO BEAM.

CAUTION: The apparatus should not be exposed to water (dripping or splashing) and no objects filled with liquids, such as vases, should be placed on the apparatus.

CAUTION concerning the Power Cord

Most appliances recommend they be placed upon a dedicated circuit;

That is, a single outlet circuit which powers only that appliance and has no additional outlets or branch circuits. Check the specification page of this owner's manual to be certain.

Do not overload wall outlets. Overloaded wall outlets, loose or damaged wall outlets, extension cords, frayed power cords, or damaged or cracked wire insulation are dangerous. Any of these conditions could result in electric shock or fire. Periodically examine the cord of your appliance, and if its appearance indicates damage or deterioration, unplug it, discontinue use of the appliance, and have the cord replaced with an exact replacement part by an authorized servicer.

Protect the power cord from physical or mechanical abuse, such as being twisted, kinked, pinched, closed in a door, or walked upon. Pay particular attention to plugs, wall outlets, and the point where the cord exits the appliance.

To disconnect power from the mains, pull out the mains cord plug. When installing the product, ensure that the plug is easily accessible.

Contents

Introduction	5-12	Operations	25-30
About the \odot Symbol Display	5	General playback features	25-26
Symbols Used in this Manual	5	If a disc menu screen is displayed	27
Notes on Discs	5	Time Search	27
Moisture Condensation	5	Marker Search	27
Handling the Unit	5	Screen Saver	27
Playable Discs	6	Using Color (A, B, C, D) Buttons	27
Regional Code	6	Displaying Disc Information On-Screen	27
BD-ROM Disc Features	7	Hybrid Discs	28
HD DVD Disc Features	8	Last Scene Memory	28
Compatibility Notes	8	Using the cursor function	28
Certain System Requirements	8	Internet connection feature	28
Important Notice for TV colour system	8	Playing an Audio CD or MP3/WMA files	29
Using an USB Flash Drive	9	MUSIC menu options	29
Using the Home Menu	9	Viewing a JPEG file	30
Front Panel	10	Reference	31-38
Display Window	11	Controlling a TV with the Supplied	
Remote Control	12	Universal Remote Control	31
Remote Control Operation	12	To program the remote to control the TV	
Installation and Setup	13-24	using the manufacturer code	31
Rear Panel	13	Code numbers of controllable TVs	32-33
HDMI connection	14	Language Codes	34
Connections to Your TV	15	Area Codes	34
Connecting to an Amplifier	16	Troubleshooting	35
Internet connection	17	Customer Support	35
Resolution Setting	18	Specifications	36
Initial Settings	19	This unit's Audio Output Specifications	37
- General Operation	19	Open source software notice	38
- [DISPLAY] Menu	19-20		
- [LANGUAGE] Menu	20		
- [AUDIO] Menu	21		
- [LOCK] Menu (Parental Control)	22		
- [NETWORK] Menu	23		
- [OTHERS] Menu	24		

Notes on Copyrights

- Because AACS (Advanced Access Content System) is approved as content protection system for BD and HD DVD format, similar to use of CSS (Content Scramble System) for DVD format, certain restrictions are imposed on playback, analog signal output, etc., of AACS protected contents. The operation of this product and restrictions on this product may vary depending on your time of purchase as those restrictions may be adopted and/or changed by AACS after the production of this product. Furthermore, BD-ROM Mark and BD+ are additionally used as content protection systems for BD format, which imposes certain restrictions including playback restrictions for BD-ROM Mark and/or BD+ protected contents. To obtain additional information on AACS, BD-ROM Mark, BD+, or this product, please contact an authorized Customer Service Center.
- Many HD DVD/BD-ROM/DVD discs are encoded with copy protection. Because of this, you should only connect your player directly to your TV, not to a VCR. Connecting to a VCR results in a distorted picture from copy-protected discs.
- This product incorporates copyright protection technologies that are protected by certain U.S. patents and other intellectual property rights owned by Macrovision Corporation and other rights owners. Use of this copyright protection technology must be authorized by Macrovision Corporation and is intended for home and other limited viewing uses only, unless otherwise authorized by Macrovision Corporation. Reverse engineering or disassembly is prohibited.
- Under the U.S. Copyright laws and Copyright laws of other countries, unauthorized recording, use, display, distribution, or revision of television programs, videotapes, HD DVDs, BD-ROM discs, DVDs, CDs and other materials may subject you to civil and/or criminal liability.

Manufactured under license from Dolby Laboratories. Dolby and the double-D symbol are trademarks of Dolby Laboratories.

Manufactured under license under U.S. Patent #'s: 5,451,942; 5,956,674; 5,974,380; 5,978,762; 6,487,535 & other U.S. and worldwide patents issued & pending. DTS and DTS Digital Surround are registered trademarks and the DTS logos and Symbol are trademarks of DTS, Inc. © 1996-2007 DTS, Inc. All Rights Reserved.

HDMI, the HDMI logo and High-Definition Multimedia Interface are trademarks or registered trademarks of HDMI licensing LLC.

Qdeo, QuietVideo and the Qdeo trademarks are registered trademarks of Marvell or its affiliates.



What is SIMPLINK?

Some functions of this unit are controlled by the TV's remote control when this unit and LG TV's with SIMPLINK are connected through HDMI connection.

- Controllable functions by LG TV's remote control; Play, Pause, Scan, Skip, Stop, Power Off, etc.
- Refer to the TV owner's manual for the details of SIMPLINK function.
- LG TV's with SIMPLINK function have the logo as shown above.

Note:

Depending on the disc type or playing status, some SIMPLINK operation may differ from your purpose or not work.

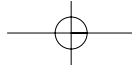

Introduction

To ensure proper use of this product, please read this owner's manual carefully and retain for future reference.

This manual provides information on the operation and maintenance of your player. Should the unit require service, contact an authorized service location.

About the \circledast Symbol Display

" \circledast " may appear on your TV display during operation and indicates that the function explained in this owner's manual is not available on that specific media.

Symbols Used in this Manual

Note:

Indicates special notes and operating features.

Tip:

Indicates tips and hints for making the task easier.

A section whose title has one of the following symbols are applicable only to the disc represented by the symbol.

- BD** BD-ROM disc
- HD DVD** HD DVD-Video disc
- DVD** DVD-Video disc
- ACD** Audio CDs
- MP3** MP3 files
- WMA** WMA files
- JPEG** JPEG files

Notes on Discs

Handling Discs

Do not touch the playback side of the disc. Hold the disc by the edges so that fingerprints do not get on the surface. Never stick paper or tape on the disc.

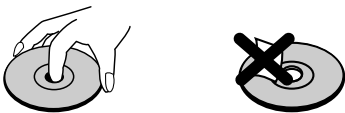

Storing Discs

After playing, store the disc in its case. Do not expose the disc to direct sunlight or sources of heat and never leave it in a parked car exposed to direct sunlight.

Cleaning Discs

Fingerprints and dust on the disc can cause poor picture quality and sound distortion. Before playing, clean the disc with a clean cloth. Wipe the disc from the center out.

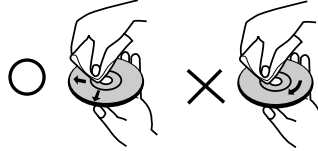

Do not use strong solvents such as alcohol, benzene, thinner, commercially available cleaners, or anti-static spray intended for older vinyl records.

Moisture Condensation

Never operate this product immediately after moving it from a cold location to a warm location. Leave it for two or three hours without operating it. If you use this product in such a situation, it may damage discs and internal parts.

Handling the Unit

When shipping the unit

Please save the original shipping carton and packing materials. If you need to ship the unit, for maximum protection, re-pack the unit as it was originally packed at the factory.

Keeping the exterior surfaces clean

Use the supplied cloth for cleaning the surfaces of the player.

- Do not use volatile liquids such as insecticide spray near the unit.
- Wiping with strong pressure may damage the surface.
- Do not leave rubber or plastic products in contact with the unit for a long period of time.

Cleaning the unit

To clean the player, use a soft, dry cloth. If the surfaces are extremely dirty, use a soft cloth lightly moistened with a mild detergent solution.

Do not use strong solvents such as alcohol, benzene, or thinner, as these might damage the surface of the unit.

Maintaining the Unit

The unit is a high-tech, precision device. If the optical pick-up lens and disc drive parts are dirty or worn, the picture quality could be diminished.

For details, please contact your nearest authorized service center.

Playable Discs



Blu-ray Disc

Discs such as movies that can be purchased or rented



HD DVD Disc

Discs such as movies that can be purchased or rented



DVD-VIDEO (8 cm / 12 cm disc)

Discs such as movies that can be purchased or rented



DVD-R (8 cm / 12 cm disc)

Video mode and finalized only
Supports the dual layer disc also



DVD-RW (8 cm / 12 cm disc)

Video mode and finalized only



DVD-RAM (8 cm / 12 cm disc)

Standard version 2.0 only



DVD+R

Finalized disc only
Supports the dual layer disc also



DVD+RW

Video mode and finalized only



Audio CD (8 cm / 12 cm disc)

Music CDs or CD-Rs/CD-RWs in music CD format that can be purchased



CD-R/CD-RW (8 cm / 12 cm disc)

CD-R/CD-RW discs that contain audio titles, MP3, WMA, or JPEG files.

Regional Code

This unit has a regional code printed on the rear of the unit. This unit can play only BD-ROM, HD DVD, or DVD discs labeled same as the rear of the unit or "ALL".

Notes:

- Depending on the conditions of the recording equipment or the CD-R/RW (or DVD±R/RW) disc itself, some CD-R/RW (or DVD±R/RW) discs cannot be played on the unit.
- Do not attach any seal or label to either side (the labeled side or the recorded side) of a disc.
- Do not use irregularly shaped discs (e.g., heart-shaped or octagonal). Doing so may result in malfunctions.
- Depending on the recording software & the finalization, some recorded discs (CD-R/RW or DVD±R/RW) may not be playable.
- DVD±R/RW and CD-R/RW discs recorded using a personal computer or a DVD or CD Recorder may not play if the disc is damaged or dirty, or if there is dirt or condensation on the player's lens.
- If you record a disc using a personal computer, even if it is recorded in a compatible format, there are cases in which it may not play because of the settings of the application software used to create the disc. (Check with the software publisher for more detailed information.)
- This player requires discs and recordings to meet certain technical standards in order to achieve optimal playback quality. Pre-recorded DVDs are automatically set to these standards. There are many different types of recordable disc formats (including CD-R containing MP3 or WMA files) and these require certain pre-existing conditions to ensure compatible playback.
- Customers should note that permission is required in order to download MP3 / WMA files and music from the Internet. Our company has no right to grant such permission. Permission should always be sought from the copyright owner.

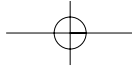

BD-ROM Disc Features

BD-ROM Discs can store 25 GB (single layer) or 50 GB (dual layer) on a single sided disc - about 5 to 10 times the capacity of a DVD.

BD-ROM Discs also support the highest quality HD video available in the industry (up to 1920 x 1080) - Large capacity means no compromise on video quality. Furthermore, a BD-ROM disc has the same familiar size and look as DVD.

- The following BD-ROM disc features are disc dependent and will vary.
- Appearance and navigation of features will also vary from disc to disc.
- Not all discs will have the features described below.
- BD-ROM Hybrid disc has both BD-ROM and DVD (or CD) layers on one side. Because this type of disc is a technology currently in development, such discs may not operate properly in this player.

Video highlights

The BD-ROM format for movie distribution supports three highly advanced video codecs, including MPEG-2, MPEG4 AVC (H.264), and SMPTE VC1. HD video resolutions are also available:

- 1920 x 1080 HD
- 1280 x 720 HD

For High-Definition Playback

To view high-definition contents from BD-ROM discs, an HDTV is required. Some discs may require HDMI OUT for viewing of high-definition contents. Ability to view high-definition contents in BD-ROM discs may be limited depending on the resolution of your TV.

Graphic planes

Two individual, full HD resolution (1920x1080) graphic planes (layers) are available, on top of the HD video layer. One plane is assigned to video-related, frame accurate graphics (like subtitles), and the other plane is assigned to interactive graphic elements, such as buttons or menus.

For both planes, various wipes, fades and scroll effects may be available.

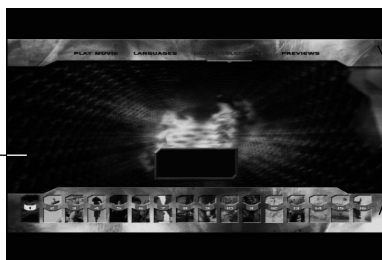

Graphic Plane

HD Video

Menu sounds

When you highlight or select a menu option, sounds can be heard such as button clicks or a voice-over explaining the highlighted menu choice.

Multi-page/PopUp Menus

With DVD-Video, playback is interrupted each time a new menu screen is accessed. Due to BD-ROM disc's ability to preload data from the disc without interrupting playback, a menu can consist of several pages.

You can browse through the menu pages or select different menu paths, while the audio and video remain playing in the background.

Interactivity

Certain BD-ROM Discs may contain animated menus and/or trivia games.

User Browsable Slideshows

With BD-ROM Discs, you can browse through various still pictures while the audio remains playing.

Subtitles

Depending on what is contained on the BD-ROM disc, you may be able to select different font styles, sizes and colors for some subtitles. Subtitles may also be animated, scrolled or faded in and out.

BD-J Interactive Capability

The BD-ROM format supports Java for interactive functions. "BD-J" offers content providers almost unlimited functionality when creating interactive BD-ROM titles.

BD-ROM Disc Compatibility

This player supports BD-ROM Profile 1 version 1.0 only. Other profiles (i.e., BD-ROM Profile 1 version 1.1 or Profile 2) could be supported through updating player's firmware later. It may be required to update the firmware in case of playing a certain newly released commercial BD-ROM disc.

For updating player's firmware, please refer to <http://sg.lgservice.com> or contact LG Electronics customer care center.

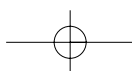

HD DVD Disc Features

HD DVD video discs are high-density, high-capacity discs.

- There are 2 types of HD DVD disc; one is standard content disc and the other is advanced content disc. Standard content disc is pure extension of DVD Video. Advanced content disc realizes more interactivity in addition to the extension of audio and video realized by standard disc.
- The HD DVD disc standard has been approved by the DVD forum.
- HD DVD (single layer): Maximum capacity of 15 GB
HD DVD (dual layer): Maximum capacity of 30 GB
A single layer single sided disc (15 GB) has capacity of about maximum 8 hours in 1125 line high definition picture; about maximum 48 hours in 525 line standard definition picture (depending on bitrate of pre-recorded contents).
- HD DVD Twin Format Discs have both HD DVD and DVD layers on one side. HD DVD Combination DVD Discs have HD DVD material on one side and standard DVD material on the other side. Because this type of disc is a technology currently in development, such discs may not operate properly in this player.
- Some titles may be played back with black "letter-box bars" because the title is recorded with bars by the contents provider.

Compatibility Notes

- Because BD-ROM and HD DVD are a new format, certain disc, digital connection and other compatibility issues are possible. If you experience compatibility problems, please contact an authorized Customer Service Center.
- Viewing high-definition content and up-converting standard DVD content may require an HDMI-capable input or HDCP-capable DVI input on your display device.
- Some BD-ROM, HD DVD and DVD discs may restrict the use of some operation commands or features.
- Dolby TrueHD, Dolby Digital Plus and DTS-HD capability is limited to 5.1 channels if you use Digital Audio or HDMI connection for the audio output of the unit.
- This player includes memory that is used to store some disc related information, including downloaded on-line content. The disc you are using will control how long this information is retained.

Certain System Requirements

For high definition video playback:

- High definition display that has COMPONENT or HDMI input jacks.
- BD-ROM or HD DVD disc with high definition content.
- HDMI or HDCP capable DVI input on your display device is required for some content (as specified by disc authors).
- For up-conversion of standard definition DVD, an HDMI or HDCP capable DVI input on your display device is required for copy protected content.

For Dolby® Digital Plus and DTS-HD multi-channel audio playback:

- An amplifier/receiver with a built-in (Dolby Digital or DTS) decoder.
- Main, center, surround speakers and subwoofer as necessary for chosen format.

Important Notice for TV colour system

The colour system of this player differs according to currently playing discs.

For example, when the player plays back the disc recorded in the NTSC colour system, the image is outputted as a NTSC signal.

Only the multi system colour TV can receive all signals outputted from the player.

Notes:

- If you have a PAL colour system TV, you will see just distorted images when using discs recorded in NTSC.
- The multi system colour TV changes the colour system automatically according to input signals. In case that the colour system is not changed automatically, turn it off and then on to see normal images on screen.
- If you try to record a NTSC output signal from the player with your recorder, the recorder may not record the signal correctly.

Using an USB Flash Drive

This unit can play the MP3 / WMA / JPEG files contained in the USB Flash Drive.

Inserting/Removing the USB Flash Drive

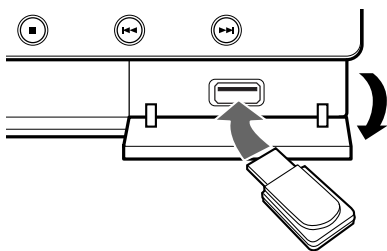

Inserting the USB Flash Drive

Insert straight-in until it fits into place.

Removing the USB Flash Drive

Withdraw the USB Flash Drive carefully.

Notes:

- This unit supports only USB Flash Drives with FAT16 or FAT32 format.
- Do not extract the USB Flash Drives during operation (play, etc.).
- A USB Flash Drive which requires additional program installation when you have connected it to a computer, is not supported.
- USB Flash Drive: USB Flash Drive that support USB1.1 and USB2.0.

Using the USB Flash Drive

1. Connect a USB Flash Drive.
2. Press HOME on the Remote Control.
3. Select [Music] or [Photo] option then press ENTER.
4. Select [USB] then press ENTER.
MUSIC (or PHOTO) menu will appear.
Details for the menu are on page 29-30.

Using the Home Menu

From the Home Menu screen you can access all the Media for playback and setting of the unit.

1. Press HOME and the Home Menu appears.

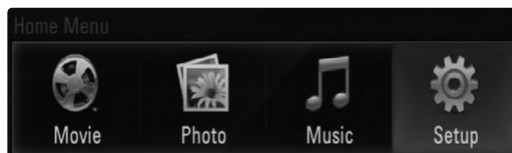

2. Use ◀ / ▶ to select the desired option then press ENTER.

[Movie] – Start video media's playback.

[Photo] – Displays PHOTO menu.

[Music] – Displays MUSIC menu.

[Setup] – Displays Setup menu.

Tip:

If you select the [Photo] or [Music] option when the USB Flash Drive is connected and a disc is inserted simultaneously, the menu for selecting a media will appear. Select a media then press ENTER.

For example:

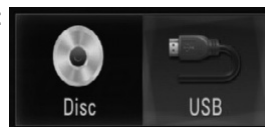

Notes:

- The unit will be in complete stop mode then HOME menu will appear if you press HOME during playback.
- If you insert a DVD or an unplayable disc that is formatted as ISO9660 or UDF, the [Photo] or [Music] option can be selected in the HOME menu. But you cannot play it

Front Panel

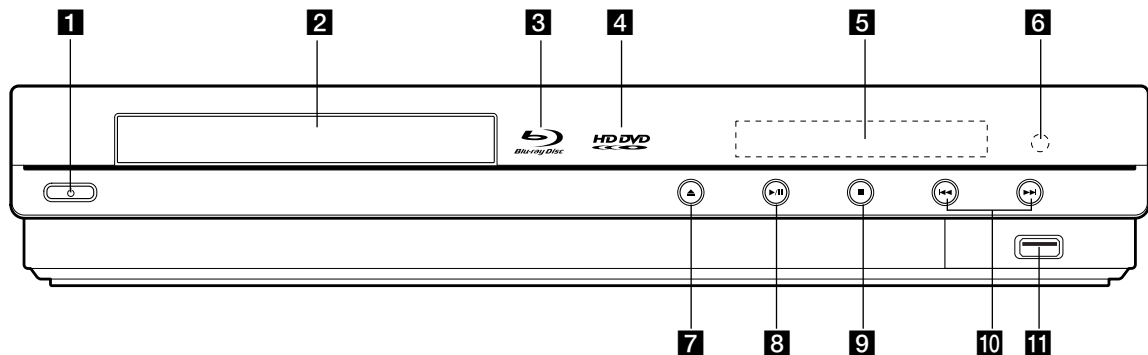

- 1 POWER Button**
Switches the unit ON or OFF.
- 2 Disc Tray**
Insert a disc here.
- 3 Blu-ray Disc Indicator**
Indicates when a BD-ROM disc is loaded.
- 4 HD DVD Indicator**
Indicates when an HD DVD disc is loaded.
- 5 Display Window**
Shows the current status of the player.
- 6 Remote Sensor**
Point the Remote Control here.
- 7 ▲ (OPEN/CLOSE)**
Opens or closes the disc tray.
- 8 ► / || (PLAY / PAUSE)**
Starts playback.
Pause playback temporarily, press again to exit pause mode.
- 9 ■ (STOP)**
Stops playback.
- 10 ◀◀ / ▶▶ (SKIP)**
Go to next or previous track/chapter.
- 11 USB Port**
Connect a USB Flash Drive.

Tip:

▲, ► / ||, ■, ◀◀ and ▶▶ buttons are operated with a slight/brief touch.

Precautions in using the touch buttons

- Use the touch buttons with clean and dry hands.
- Do not press the touch buttons with too much force.
- Do not touch the button with any conductive material such as metallic object (Disc, etc). It may cause a malfunction.

Display Window

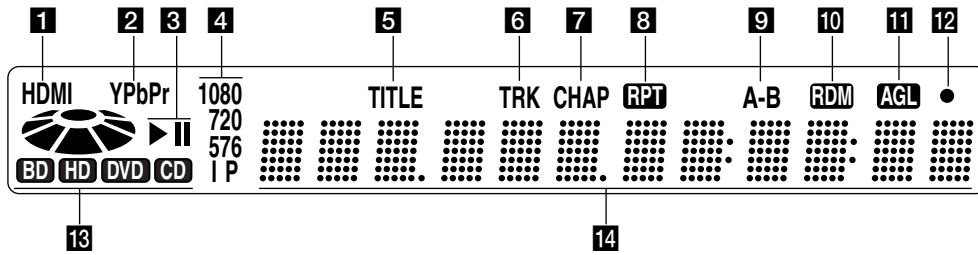

- 1 HDMI Indicator**
Indicates when the HDMI output is available.
- 2 YPbPr Indicator**
Indicates when the component video output is available.
- 3 Status Indicator**
▶: Playing
||: Paused
- 4 Video Output Resolution Indicator**
Displays the video output resolution currently selected.
576i: 576 interlace
576p: 576 progressive
720p: 720 progressive
1080i: 1080 interlace
1080p: 1080 progressive
- 5 TITLE**
Indicates current title number.
- 6 TRK (Track) Indicator**
Indicates current track number.
- 7 CHAP (Chapter) Indicator**
Indicates current chapter number.
- 8 Repeat Mode Indicator**
Indicates when playing in repeat mode.
- 9 A-B Repeat Mode Indicator**
Indicates when playing in A-B repeat mode.
- 10 RDM (Random) Indicator**
Indicates when playing in random order.
- 11 AGL (Angle) Indicator**
Indicates when playing a scene recorded with multi angles.
- 12 Remote Control Indicator**
Indicates when Remote Control signal is received.
- 13 Disc Indicator**
BD: Indicates when an BD-ROM disc is loaded.
HD DVD: Indicates when an HD DVD disc is loaded.
DVD: Illuminates when a DVD disc is loaded.
CD: Illuminates when a Audio CD, MP3/WMA or JPEG disc is loaded.
- 14 Character Indicators**
Indicates total playing time, elapsed time, title number, chapter number or message, etc.

Remote Control

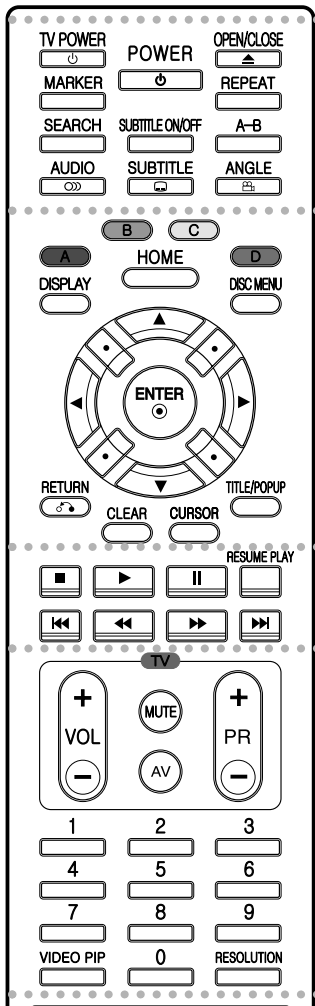

- • • • • **1** • • • • •
- POWER:** Switches the player ON or OFF.
- TV POWER:** Switches the TV ON or OFF.
- OPEN/CLOSE (▲):** Opens and closes the disc tray.

MARKER: Marks any point during playback.

SEARCH: Displays Marker Search menu.

AUDIO (⊞): Selects an audio language or audio channel.

SUBTITLE ON/OFF: Switches the subtitle on or off.

SUBTITLE (☺): Selects a subtitle language.

REPEAT: Repeat a desired section.

A-B: Repeat sequence.

ANGLE (⌂): Selects a disc camera angle, if available.

- • • • • **2** • • • • •
- Color (A, B, C, D) buttons:** Are used for some BD-J or HD DVD interactivity applications. They are also used for [PHOTO] and [MUSIC] menu.

DISPLAY: Accesses On-Screen Display.

HOME: Accesses the Home Menu.

DISC MENU: Accesses menu on a disc.

Direction buttons: Select an option in the menu.

ENTER (⊙): Acknowledges menu selection.

RETURN (↶): Exits the menu.

CLEAR: Removes a mark on the Marker Search menu or a number when setting the password.

CURSOR*: Use while a HD DVD with support for cursor use is playing.

TITLE/POP UP: Displays the DVD or HD DVD's title menu or BD-ROM's popup menu, if available.

- • • • • **3** • • • • •

■ **(STOP):** Stops playback.

▶ **(PLAY):** Starts playback.

⏸ **(PAUSE/STEP):** Pauses playback.

RESUME PLAY*: Resumes playback from the location last stopped when a disc menu appears.

◀◀ / ▶▶ **(SCAN):** Search backward or forward.

⏪ / ⏩ **(SKIP):** Go to next or previous chapter.

- • • • • **4** • • • • •

TV Control Buttons: See page 31.

0-9 numerical buttons: Select numbered options in a menu.

VIDEO PIP*: Switches PIP function on or off, if available (BD-ROM only).

RESOLUTION: Sets the output resolution for HDMI and COMPONENT VIDEO OUT jacks.

* Depending on a disc type or the pre-recorded contents of the HD DVD and BD, different functions may be executed than other media or there are no responses when pressing some buttons.

Remote Control Operation

Point the Remote Control at the remote sensor and press the buttons.

Caution

Do not mix old and new batteries. Never mix different types of batteries (standard, alkaline, etc.).

Remote Control Battery Installation

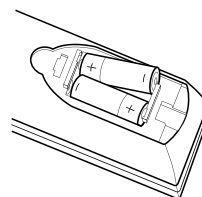

Remove the battery cover on the rear of the Remote Control, and insert two R03 (size AAA) batteries with + and - matched correctly.

Installation and Setup

Rear Panel

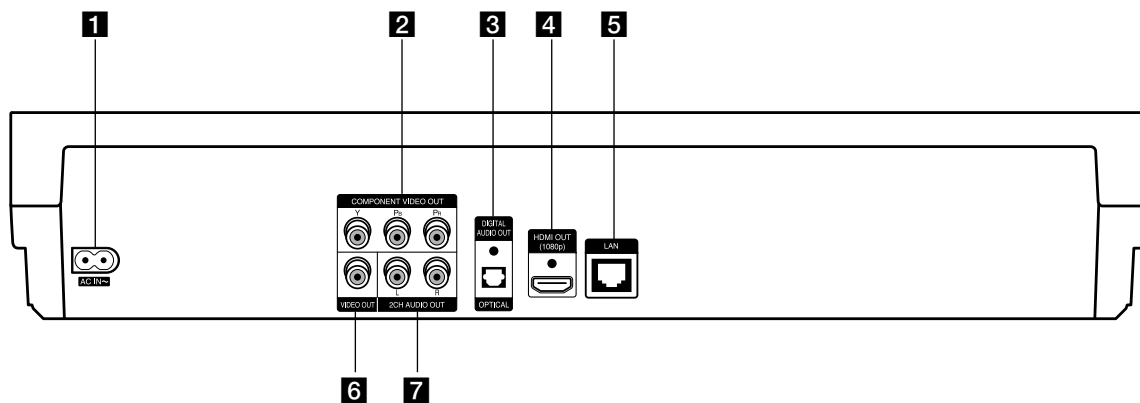

1 AC IN connector

Connect the supplied power cord.

2 COMPONENT VIDEO OUT (Y Pb Pr)

Connect to a TV with Y Pb Pr inputs.

3 DIGITAL AUDIO OUT (OPTICAL)

Connect to digital (optical) audio equipment.

4 HDMI OUT (Type A)

Connect to TV with HDMI inputs. (Interface for digital audio and video)

5 LAN port

Connect a network with an always-on broadband connection.

6 VIDEO OUT

Connect to a TV with video inputs.

7 2CH AUDIO OUT (Left/Right)

Connect to a TV with 2 channel audio inputs.

HDMI connection

If you have a HDMI TV or monitor, you can connect it to this player using a HDMI cable.

1. Connect the HDMI jack on the player to the HDMI jack on a HDMI compatible TV or monitor (**H**).
2. Set the TV's source to HDMI (refer to TV's Owner's manual).

Notes:

- You must select a HDMI audio output and a maximum sampling frequency that your TV accepts using [HDMI] and [Sampling Freq.] options on the setup menu (See page 21).
- If a connected HDMI device does not accept the audio output of the unit, the HDMI device's audio sound may be distorted or may not output.

Tip:

When you use HDMI connection, you can change the resolution for the HDMI output. (Refer to "Resolution Setting" on page 18.)

Cautions

- Changing the resolution when the connection has already been established may result in malfunctions. To solve the problem, turn off the player and then turn it on again.
- When the HDMI connection with HDCP is not verified, TV screen is changed to black screen. In this case, check the the HDMI connection, or disconnect the HDMI cable.
- If there is noise or lines on the screen, please check the HDMI cable (length is generally limited to 15ft).

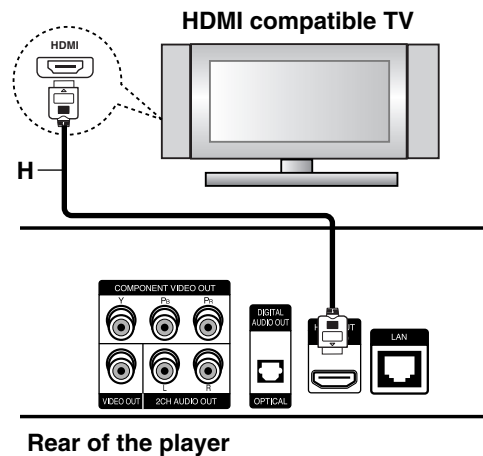

Additional Information for HDMI

- When you connect a HDMI or DVI compatible device make sure of the followings:
 - Try switching off the HDMI/DVI device and this player. Next, switch on the HDMI/DVI device and leave it for around 30 seconds, then switch on this player.
 - The connected device's video input is set correctly for this unit.
 - The connected device is compatible with 720x576p, 1280x720p, 1920x1080i or 1920x1080p video input.
- Not all HDCP-compatible DVI devices will work with this player.
 - The picture will not be displayed properly with non-HDCP device.
 - This player does not playback and TV screen is changed to black screen

Connections to Your TV

Make one of the following connections, depending on the capabilities of your existing equipment.

Tips

- Depending on your TV and other equipment you wish to connect, there are various ways you could connect the player. Use only one of the connections described below.
- Please refer to the manuals of your TV, Stereo System or other devices as necessary to make the best connections.

Caution

- Make sure the player is connected directly to the TV. Tune the TV to the correct video input channel.
- Do not connect the player's AUDIO OUT jack to the phono in jack (record player) of your audio system.
- Do not connect your player via your VCR. The image could be distorted by the copy protection system.

Component Video Connection

Connect the COMPONENT VIDEO OUT jacks on the player to the corresponding input jacks on the TV using Y Pb Pr cables (**C**).

Tip:

When you use COMPONENT VIDEO OUT connection, you can change the resolution for the output. (Refer to "Resolution setting" on page 18.)

Video Connection

Connect the VIDEO OUT jack on the player to the video in jack on the TV using a video cable (**V**).

Audio (Left/Right) Connection

Connect the left and right 2CH AUDIO OUT jacks of the player to the audio left and right IN jacks on the TV using the audio cables (**A**).

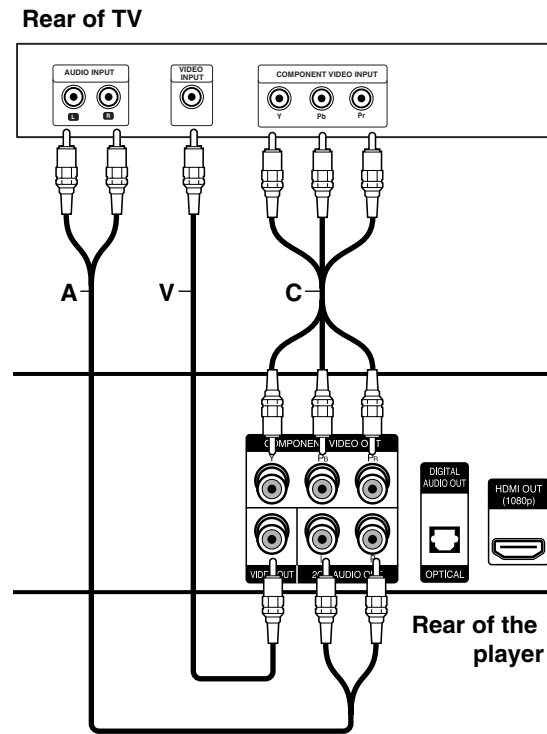

Connecting to an Amplifier

Make one of the following connections, depending on the capabilities of your existing equipment.

Note:

Since many factors affect the type of audio output, see "The unit's Audio Output Specifications" on page 37 for details.

Connecting to an Amplifier via 2 Channel Audio Output

Connect the Left and Right 2CH AUDIO OUT jacks on the player to the audio left and right in jacks on your amplifier, receiver, or stereo system, using audio cables (**A**).

Connecting to an Amplifier via Digital Audio Output (Optical)

1. Connect the player's DIGITAL AUDIO OUT jack to the corresponding in jack on your amplifier. Use a digital audio cable (**O**).
2. You will need to activate the player's digital output. (See "[AUDIO] Menu" on page 21.)

Connecting to an Amplifier via HDMI Output

1. Connect the player's HDMI OUT jack to the corresponding in jack on your amplifier. Use an HDMI cable (**H1**).
2. You will need to activate the player's digital output. (See "[AUDIO] Menu" on page 21.)

Tip:

Connect the amplifier's HDMI output jack to HDMI input jack on your TV using an HDMI cable (**H2**) if your amplifier has HDMI output jack.

Digital Multi-channel sound

A digital multi-channel connection provides the best sound quality. For this you need a multi-channel Audio/Video Receiver that supports one or more of the audio formats supported by your player. Check the receiver manual and the logos on the front of the receiver. (PCM Stereo, PCM Multi-Ch, Dolby Digital and/or DTS)

Notes:

- You must select a digital audio output and a maximum sampling frequency that your Amplifier (or AV receiver) accepts using [SPDIF], [HDMI] and [Sampling Freq.] options on the setup menu (See page 21).
- With digital audio connection (SPDIF or HDMI), Disc Menu button sounds of BD-ROM or HD DVD may not be heard if the [SPDIF] or [HDMI] option is set to [Primary Pass-Thru].
- If the audio format of the digital output does not match the capabilities of your receiver, the receiver will produce a strong, distorted sound or no sound at all.
- Multi-channel Digital Surround Sound via digital connection can only be obtained if your receiver is equipped with a Digital Multi-channel decoder.
- To see the audio format of the current disc in the on-screen display, press AUDIO.

Rear of the player

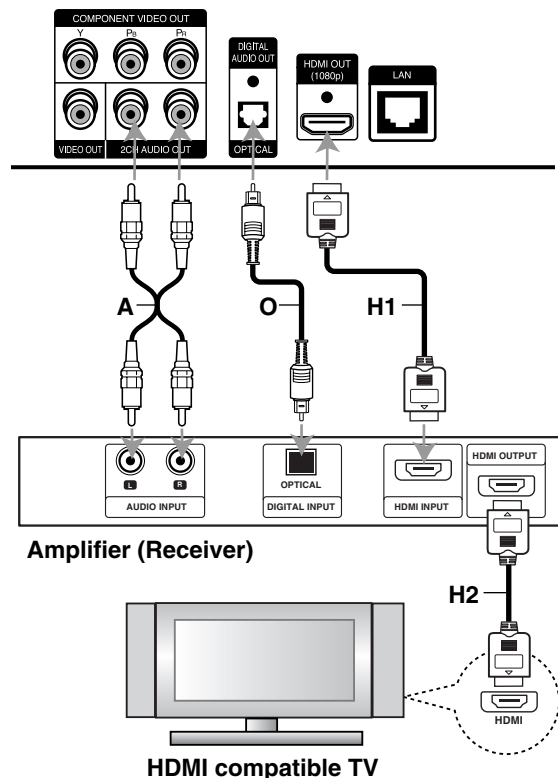

Internet connection

This player can be connected to a local area network (LAN) via the LAN port on the rear panel. After making the physical connection the player needs to be set up for network communication. This is done from the [Setup] menu — see “[NETWORK] Menu” on page 23 for detailed instructions. This connection is used to access special HD DVD or BD-ROM sites.

Connect the player’s LAN port to the corresponding port on your Modem or Router using a LAN cable. Use a commercially available straight LAN cable (Category 5/CAT5 or better with RJ45 connector).

Cautions:

- When plugging or unplugging the LAN cable, hold the plug portion of the cable. When unplugging, do not pull on the LAN cable but unplug while pressing down on the lock.
- Do not connect a modular phone cable to the LAN port.
- Since there are various connection configurations, please follow the specifications of your telecommunication carrier or internet service provider.

Rear of the player

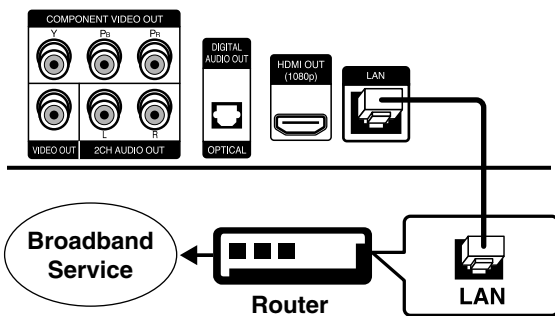

Notes:

- Depending on the internet service provider (ISP), the number of devices that can receive internet service may be limited by the applicable terms of service. For details, contact your ISP.
- Our company is not responsible for any malfunction of the player and/or the internet connection feature due to communication errors/malfunctions associated with your broadband internet connection, or other connected equipment.
- Our company is not responsible for any trouble in your internet connection.

- If you wish to use a wireless network to connect the player, you will need to use a wireless LAN ethernet adapter to connect the player to the network.
- The features of HD DVD or BD-ROM discs made available through the Internet Connection feature are not created or provided by our company, and our company is not responsible for their functionality or continued availability. Some disc related material available by the Internet Connection may not be compatible with this player. If you have questions about such content, please contact the producer of the disc.
- Some internet contents may require a higher bandwidth connection.
- Even if the player is properly connected and configured, some internet contents may not operate properly because of internet congestion, the quality or bandwidth of your internet service, problems at the provider of the content or compatibility issues.
- Some internet connection operations may not be possible due to certain restrictions set by the Internet service provider (ISP) supplying your broadband Internet connection.
- Any fees charged by an ISP including, without limitation, connection charges are your responsibility.
- A 10 Base-T or 100 Base-TX LAN port is required for connection to this player. If your internet service does not allow for such a connection, you will not be able to connect the player.
- You must use a Router to use xDSL service.
- A DSL modem is required to use DSL service and a cable modem is required to use cable modem service. Depending on the access method of and subscriber agreement with your ISP, you may not be able to use the internet connection feature contained in this player or you may be limited to the number of devices you can connect at the same time. (If your ISP limits subscription to one device, this player may not be allowed to connect when a PC is already connected.)
- The use of a “Router” may not be allowed or its usage may be limited depending on the policies and restrictions of your ISP. For details, contact your ISP directly.
- Your ISP may protect this player from being connected to network when confirming MAC ADDRESS. In that case, contact your ISP to request to initialize MAC ADDRESS.

Resolution Setting

The player provides several output resolutions for HDMI OUT and COMPONENT VIDEO OUT jacks. You can change the resolution using [Setup] menu or pressing the RESOLUTION button in complete stop mode.

Auto – If the HDMI OUT jack is connected for TVs providing display information (EDID), automatically selects the resolution best suited to the connected TV (1080p, 1080i, 720p or 576p). (only for HDMI connection)

1080p – Outputs 1080 lines of progressive video. (only for HDMI connection)

1080i – Outputs 1080 lines of interlaced video.

720p – Outputs 720 lines of progressive video.

576p – Outputs 576 lines progressive video.

576i – Outputs 576 lines of interlaced video. (only for COMPONENT VIDEO OUT connections)

How to change the resolution using RESOLUTION button

Press RESOLUTION button in complete stop mode.

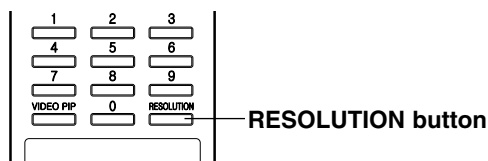

How to change the resolution using Setup menu

1. Press HOME and the Home Menu appears.
2. Select [Setup] and press ENTER. The Setup menu appears.
3. Use ▲ / ▼ to select [DISPLAY] option then press ► to move to the second level.
4. Use ▲ / ▼ to select the [Resolution] option then press ► to move to the third level.



5. Use ▲ / ▼ to select the desired resolution then press ENTER to confirm your selection.

Available resolution according to connection

HDMI OUT connection

- Auto, 1080p, 1080i, 720p and 576p are available.
- 576i is not available.
- If you select a resolution manually and then connect the HDMI jack to TV and your TV does not accept it, the resolution setting is set to [Auto].
- If you select a resolution that your TV does not accept, the warning message appears for a while then it disappears. You must select a resolution that your TV does accept.
- The 1080p video output frame rate may be automatically set to either 24Hz or 50Hz (or 60Hz) depending both on the capability and preference of the connected TV and based on the native video frame rate of the content on the Blu-ray disc or HD DVD.

COMPONENT VIDEO OUT connection

- 1080i, 720p, 576p and 576i are available.
- The resolution may be limited depending on the title in BD-ROM, HD DVD and DVD.
- If the disc is copy protected, the resolution will be changed to 576p or 480p automatically.
- 1080p is not available.

VIDEO OUT connection

- The resolution of the VIDEO OUT jack is fixed to 576i.

Notes:

- Depending on your display, some of the resolution settings may result in the picture disappearing or an abnormal picture appearing. In this case, press STOP twice then RESOLUTION repeatedly until the picture re-appears.
- This player supports simultaneous output of video on its HDMI OUT and COMPONENT VIDEO OUT jacks. The resolution on the HDMI output will be the same as the resolution output on the component video output. Thus, because the HDMI output can change automatically to match the maximum available resolution of your display when [Resolution] option is set to [Auto] on the setup menu, if you connect both the HDMI output and component video output, the resolution on the component video output will change if the HDMI output Auto-adjusts.

Initial Settings

By using the Setup menu, you can make various adjustments to items such as picture and sound. You can also set a language for the subtitles and the Setup menu, among other things. For details on each Setup menu item, see pages 19 to 24.

To display and exit the Menu:

Press HOME and the Home Menu appears. Select [Setup] then press ENTER, and Setup menu appears.

Press RETURN or HOME to exit the Setup menu.

To go to the next level:

Press ► on the Remote Control.

To go back to the previous level:

Press ◀ on the Remote Control.

General Operation

1. Press HOME and the Home Menu appears.
2. Select [Setup] and press ENTER. The Setup menu appears.

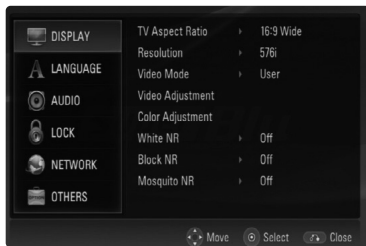

3. Use ▲ / ▼ to select the desired option then press ► to move to the second level. The screen shows the current setting for the selected item, as well as alternate setting(s).
4. Use ▲ / ▼ to select the second desired option then press ► to move to the third level.
5. Use ▲ / ▼ to select the desired setting then press ENTER to confirm your selection. Some items require additional steps.
6. Press RETURN or HOME to exit the Setup menu.

[DISPLAY] Menu

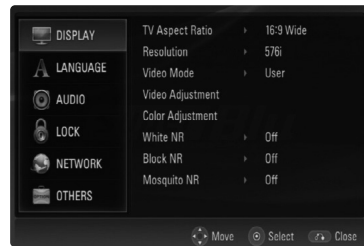

TV Aspect Ratio

[4:3 Letter Box] – Select when a standard 4:3 TV is connected. Displays theatrical images with masking bars above and below the picture.

[4:3 Pan Scan] – Select when a standard 4:3 TV is connected. Displays pictures cropped to fill your TV screen. Both sides of the picture are cut off.

[16:9 Wide] – Select when a 16:9 wide TV is connected.

Note:

You cannot select [4:3 Letter Box] and [4:3 Pan Scan] option when the resolution is set to higher than 720p.

Resolution

Sets the output resolution of the Component and HDMI video signal.

Refer to “Resolution Setting” on page 18 for details about the resolution.

[DISPLAY] Menu (Continued)

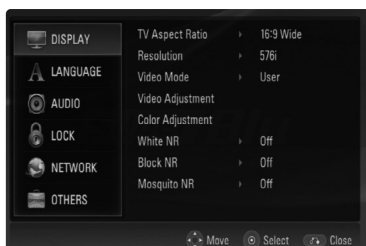

Video Mode

Select the video mode during play.

[Default] QDEO – The video is adjusted automatically. Qdeo delivers rich high-definition video quality through a suite of advanced QuietVideo™ technologies. You cannot adjust other video adjustment options.

[User] – You can make further adjustments for video using [Video Adjustment], [Color Adjustment], [White NR], [Block NR], and [Mosquito NR] options.

Video Adjustment

You can adjust Contrast, Brightness, Sharpness or Color.

1. Select [Video Adjustment] option then press ENTER.
The menu for video adjustment will appear
2. Use ▲ / ▼ to select a desired option then use ◀ / ▶ to adjust the value.
 - Select [Default] option then press ENTER to reset the video adjustment.
 - Select [Close] option then press ENTER to exit the [Video Adjustment] menu.

Color Adjustment

You can adjust picture's color.

1. Select [Color Adjustment] option then press ENTER.
The menu for color adjustment will appear
2. Use ▲ / ▼ to select a desired option then use ◀ / ▶ to adjust the value.
 - Select [Default] option then press ENTER to reset the color adjustment.
 - Select [Close] option then press ENTER to exit the [Color Adjustment] menu.

White NR (White Noise Reduction)

Enhance the video quality by reducing the white (random) noise of the digital video.
The higher White NR level makes the video softer.

Block NR (Block Noise Reduction)

Set to [On] to reduce the block noise, which may appear especially on fast-moving pictures, produced in the MPEG compression process.

Mosquito NR (Mosquito Noise Reduction)

Set to [On] to reduce the mosquito (scattering) noise produced in the MPEG compression process.

[LANGUAGE] Menu

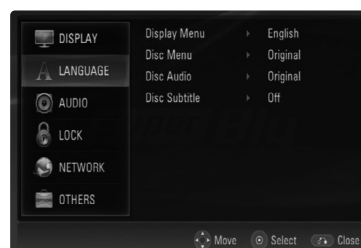

Display Menu

Select a language for the Setup menu and on-screen display.

Disc Menu / Disc Audio / Disc Subtitle

Select the language you prefer for the audio track (disc audio), subtitles, and the disc menu.

[Original] – Refers to the original language in which the disc was recorded.

[Other] – To select another language, press number buttons then ENTER to enter the corresponding 4-digit number according to the language code list on page 33.

[Off] (for Disc Subtitle) – Turn off Subtitle.

Note:

Depending on a disc, your language setting may not be worked for some disc.

[AUDIO] Menu

Each disc has a variety of audio output options. Set the player's Audio options according to the type of audio system you use.

Note:

Since many factors affect the type of audio output, see "The unit's Audio Output Specifications" on page 37 for details.

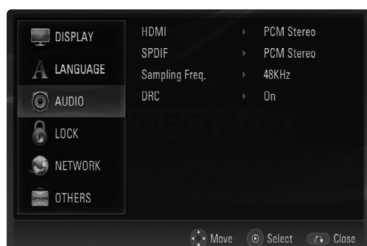

HDMI / SPDIF (Digital Audio Output)

Select the output sound format when a device equipped with an HDMI or Digital Audio input jack is connected to the HDMI OUT or DIGITAL AUDIO OUT jack on this player.

[PCM Stereo] – Select if you connect this unit's HDMI OUT or DIGITAL AUDIO OUT jack to a device with two-channel digital stereo decoder.

[PCM Multi-Ch] (HDMI only) – Select if you connect this unit's HDMI OUT jack to a device with multi-channel digital decoder.

[DTS Re-Encode] – Select if you connect this unit's HDMI OUT or DIGITAL AUDIO OUT jack to a device with DTS decoder.

[Primary Pass-Thru] – Select if you connect this unit's DIGITAL AUDIO OUT and HDMI OUT jack to a device with LPCM, Dolby Digital and DTS.

Notes:

- When [HDMI] option is set to [PCM Multi-CH], the audio may output as PCM Stereo if the PCM Multi-Ch information is not detected from HDMI device with EDID.
- When [HDMI] and [SPDIF] options are set to [DTS Re-Encode], the DTS audio will output on BD and HD DVD advanced disc, and the original audio will output on the other discs.

Sampling Freq. (Maximum Sampling Frequency)

[192KHz] – Select this if your A/V Receiver or Amplifier is capable of handling 192 KHz signals.

[96KHz] – Select this if your A/V Receiver or Amplifier is NOT capable of handling 192 KHz signals. When this choice is made, this unit automatically converts any 192 KHz signals to 96 KHz so your system can decode them.

[48KHz] – Select this if your A/V Receiver or Amplifier is NOT capable of handling 192 KHz and 96 KHz signal. When this choice is made, this unit automatically converts any 192 KHz and 96 KHz signals to 48 KHz so your system can decode them.

Check the documentation for your A/V Receiver or Amplifier to verify its capabilities.

DRC (Dynamic Range Control)

During the disc encoded in Dolby Digital or Dolby Digital Plus is playing back, you may wish to compress the dynamic range of the audio output (the difference between the loudest sounds and the quietest ones). This allows you to listen to a movie at a lower volume without losing clarity of sound. Set DRC to [On] for this effect.

[LOCK] Menu (Parental Control)

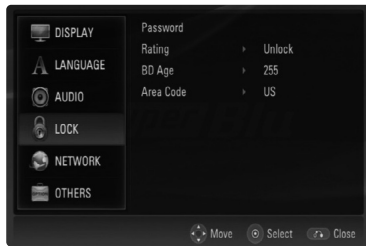

Password

You can enter or change the password.

1. Select [Password] option on the [LOCK] menu then press ►.
2. To create new password, press ENTER when the [New] option is highlighted. Input new password and press ENTER. Enter it again and press ENTER to verify.

To change the password, press ENTER when the [Change] option is highlighted, then input old password and press ENTER. Input new password and press ENTER. Enter it again and press ENTER to verify.

To delete the password, select [Delete] option then press ENTER, then input old password and press ENTER. The password is deleted.

Tip:

If you make a mistake before pressing ENTER, press CLEAR. Then input the correct password.

If you forget your password

If you forget your password, you can clear it using the following steps:

1. Remove any disc that might be in the player.
2. Select [Password] option.
3. Use Number buttons to enter the 6-digit number "210499".

The "PIN CLEAR" appears in the display window and the password is deleted.

Rating

Blocks playback of rated disc based on their content. (Not all discs are rated.)

1. Select [Rating] on the [LOCK] menu then press ►.
2. To access this option, you must input the password you have created. If you have not yet entered password, you will be prompted to do so. Input a password and press ENTER. Enter it again and press ENTER to verify. If you make a mistake before pressing ENTER, press CLEAR.
3. Select a rating from 1 to 8 using the ▲ / ▼ buttons.

[Rating 1-8] – Rating one (1) has the most restrictions and rating eight (8) is the least restrictive.

[Unlock] – If you select unlock, parental control is not active and the disc plays in full.

4. Press ENTER to confirm your rating selection.

BD Age

Set an age limit of BD-ROM play.

1. Select [BD Age] on the [LOCK] menu then press ►.
2. Follow step 2 as shown above (Rating).
3. Use number buttons to input an age limit for BD-ROM viewing.

[255] – All BD-ROM can be played.

[0-254] – Prohibits play of BD-ROM with corresponding ratings recorded on them.

4. Press ENTER to confirm your selection.

Area Code

Enter the code of the area whose standards were used to rate the DVD video disc, based on the list on page 34.

1. Select [Area Code] on the [LOCK] menu then press ►.
2. Follow step 2 as shown above (Rating).
3. Select the first character using ▲ / ▼ buttons then press ENTER.
4. Select the second character using ▲ / ▼ buttons then press ENTER to confirm your selection.

[NETWORK] Menu

Some HD DVD or BD-ROM discs may enable you to access special HD DVD or BD-ROM sites, if you connect the player to the Internet. For example, if an HD DVD or BD-ROM site includes content such as links to future movie trailers, you can watch the downloaded on-line content on the player. You do not need to connect to a PC to use this function.

Preparations:

- This feature requires an always-on broadband internet connection. (See page 17.)
- An BD-ROM or HD DVD disc compatible with this feature is required. Not all BD-ROM or HD DVD discs are compatible.

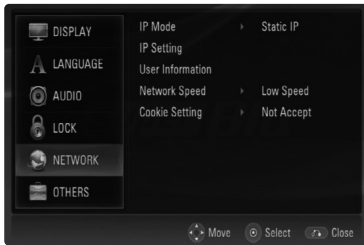

IP Mode

If there is a DHCP server on the local area network (LAN), this player will automatically be allocated an IP address. If you're using a broadband router or broadband modem that has a DHCP (Dynamic Host Configuration Protocol) server function, select [Dynamic IP]. The IP address will automatically be determined.

If there is no DHCP server on the network and you want to set the IP address manually, select [Static IP] then set the [IP Address], [Subnet Mask], [Gateway] and [DNS Server] using [IP Setting] option.

Note:

The [IP Mode] menu shows if the internet is connected or not. "Ø" will appear when connection is failed.

IP Setting

This option is available only if [IP Mode] option is set to [Static IP].

Use the ▲ / ▼ / ◀ / ▶ buttons to select a field; use the number buttons to enter a value. Press ENTER when [OK] is highlighted to finish and exit the screen.

User Information

Although not directly related to the Internet connection, some BD-ROM or HD DVD discs may require the following settings to be configured.

1. Select [User Information] on the [NETWORK] menu then press ▶.
2. Input characters for user ID by pressing ▲ / ▼. To shift the position, press ◀ / ▶. Up to 10 characters can be input.
3. Press ENTER to shift to [Password] option.
4. Input characters for password by pressing ▲ / ▼. To shift the position, press ◀ / ▶. Up to 10 characters can be input.

Tip:

If you make a mistake, press CLEAR. Then input the correct characters.

Network Speed

Select a speed according to the specification of your LAN.

[Low Speed] – Lower than 1 Mbps

[Mid Speed] – 1-10 Mbps

[High Speed] – Higher than 10 Mbps

Cookie Setting

Select whether you wish to accept "cookies" or not.

[Accept] – Cookies are accepted.

[Not Accept] – Cookies are rejected. This may disable some services on web pages.

Note:

If you select to accept "cookies", the BD-ROM or HD DVD internet services you use may record or track information about your use of the player and/or those sites. If you do not choose to allow cookies, some or all features of a site may not properly function.

[OTHERS] Menu

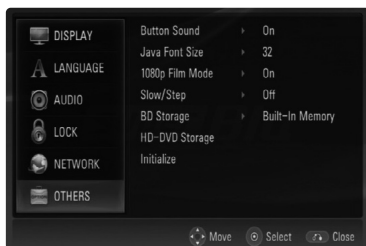

Button Sound

You can hear beep sound when you press a touch button on the front panel. Set [On] for this effect.

Java Font Size **BD**

You can adjust the default text size displayed for the BD-J contents during BD-ROM playback. This setting is only valid when BD-J contents do not set the size of text.

Please select a font size bigger than 24 when the player is connected with an HD TV.

1080p Film Mode

When the resolution is set to 1080p, select [On] for smooth presentation of film material (1080/24p or 720/24p video) with an HDMI-equipped display compatible with 1080/24p input.

Notes:

- When you select [On], you may experience some picture disturbance when the video switches video and film material. In this case, select [Off].
- Even when [1080p Film Mode] is set to [On], if your TV is not compatible with 1080/24p, the actual frame frequency of the video output will be 60 Hz or 50 Hz.

Slow/Step **DVD HD DVD BD**

You can set up the operations of the **II** (Pause) and **▶▶** (Forward Scan) while the playback is paused.

[Off] – If you press **II** while the playback is paused and the picture play backs in normal. If you press **▶▶** while the playback is paused and the picture play backs in fast forward.

[On] – If you press **II** while the playback is paused and the picture play backs in frame-by-frame. If you press **▶▶** while the playback is paused and the picture play backs in slow motion.

Note:

We recommend setting the [Slow/Step] option to [Off] for HD DVD interactivity.

BD Storage **BD**

This player includes memory that is used to store some BD-ROM disc related information, including downloaded on-line content. The disc you are using will control how long this information is retained.

[Built-In Memory] – Saves the downloaded on-line contents in built-in memory.

[USB Memory] – Saves the downloaded on-line contents in the USB Flash Drive if connected.

HD-DVD Storage **HD DVD**

You can erase or copy the downloaded on-line content for HD DVD in the built-in memory or USB Flash Drive.

1. Select [HD-DVD Storage] on the [OTHERS] menu then press **▶**.
The [Persistence Storage] menu will appear.
2. Select [Built In Memory] or [USB1] then press **▶**.
[Built-In Memory] – Shows the contents in the built-in memory.
[USB 1] – Shows the contents in the USB Flash Drive.
3. Select a folder then press **▶**.
The contents in the folder will appear.
4. Highlight an option and then press ENTER.

[Copy] – Copies the contents from the built-in memory to USB Flash Drive. (or from USB Flash Drive to the built-in memory).

[Delete] – Deletes the contents in the built-in memory or USB Flash Drive.

[Close] – Returns to the [Persistence Storage] menu.

5. Select an option then press ENTER.

Note:

The [Common Area] folder is created by default if this folder is not existed in the [Built-In Memory].

Initialize

You can reset the player to its original factory settings and initialize the BD Storage or HD-DVD Storage.

1. Select [Initialize] option then press **▶**.
2. Press **▲** / **▼** to select the desired option then press ENTER.
The confirm message will appear.

[Factory Set] – If you need to, you can reset the player to all its factory settings. Some options cannot be reset. (Rating, Password, Area Code and BD/HD Storage)

[BD Flash Format] – Initializes the BD contents from the built-in memory: BD contents recorded on the built-in memory will be erased.

[HD-DVD Flash Format] – Initializes the HD-DVD contents from the built-in memory: HD-DVD contents recorded on the built-in memory will be erased.

3. Use **◀** / **▶** to select [Yes] or [No] then press ENTER.

Operations

General playback features

1. Load your chosen disc in the tray, with the playback side down.
2. Start playback using the HOME menu (See page 9).

Buttons	Operations	Discs
OPEN / CLOSE (▲)	Opens or closes the disc tray.	All Discs
■ (STOP)	Stops the playback. The unit records the stopped point, depending on the disc. "■■■" appears on the screen briefly. Press ► (PLAY) to resume playback (from the scene point). If you press STOP (■) again or unload the disc ("■" appears on the screen.), the unit will clear the stopped point. (■■■ = Resume Stop, ■ = Complete Stop) Note: The resume point may be cleared when a button is pressed (for example; POWER, OPEN/CLOSE, etc). On HD DVD advanced title and BD interactive title, the unit will be in Complete Stop mode if you press STOP once during playback.	All Discs DVD ACD MP3 WMA HD DVD BD
RESUME PLAY	Disc menu will appear if you press DISC MENU once. To resume playback, press RESUME PLAY. Notes: <ul style="list-style-type: none"> • The RESUME PLAY may not work on some discs. • On other disc, RESUME PLAY is operated as ► (PLAY). 	HD DVD BD
■■ (PAUSE)	During playback, press ■■ to pause playback. Tip: During Audio CD or MP3/WMA playback, press ■■ once again to resume playback. Press ■■ repeatedly to play Frame-by-Frame. Note: ■■ (PAUSE) button's operation are differ depending on the [Slow/Step] option setting on the setup menu. (See page 24.)	All Discs DVD HD DVD BD
◀◀ / ▶▶ (SKIP)	During playback, press ◀◀ or ▶▶ to go to the next chapter/track/file or to return to the beginning of the current chapter/track/file. Press ◀◀ twice briefly to step back to the previous chapter/track/file.	All Discs
◀◀ / ▶▶ (SCAN)	During playback, press SCAN (◀◀ or ▶▶) repeatedly to select the required scan speed. - DVD, HD DVD, BD: 5 steps, - Audio CD, MP3, WMA: 3 steps While the playback is paused, press SCAN ▶▶ repeatedly to play in slow motion (4 steps, forward only). Note: ▶▶ (SCAN) button's operation are differ depending on the [Slow/Step] option setting on the setup menu. (See page 24.)	All Discs DVD HD DVD BD

Continued →

General playback features (Continued)

Buttons	Operations	Discs
REPEAT	<p>During playback, press REPEAT repeatedly to select a desired repeat mode. DVD, HD DVD, BD: Chapter/Title/Off Audio CD, MP3, WMA: Track/All/Off</p> <p>Note: If you press ▶▶ once during Repeat Chapter/Track playback, the repeat playback cancels.</p>	<p>DVD BD ACD MP3 WMA</p>
A-B	<p>During playback, each press of A-B button to select point A and point B and repeats a sequence from point A (Starting point) to point B (End point). To cancel the sequence, press A-B.</p>	DVD BD ACD
TITLE/POP UP	<p>If the current DVD, HD DVD or BD-ROM disc has a menu, the Title menu or Popup menu appears on the screen. Depending on the disc, the menu may not be available.</p>	DVD HD DVD BD
DISC MENU	<p>The menu appears on the screen. Depending on the disc, the menu may not be available.</p>	DVD HD DVD BD
ANGLE (📷)	<p>During playback of the disc contains scenes recorded at different camera angles, press ANGLE repeatedly to select a desired angle.</p> <p>Note: When you are playing a disc containing scenes recorded at different camera angles, the angle indicator will appear on the TV screen for a while and display window during scenes recorded at different angles as an indication that angle switching is possible.</p>	DVD HD DVD BD
SUBTITLE (🗨)	<p>During playback, press SUBTITLE repeatedly to select a desired subtitle language.</p>	DVD HD DVD BD
SUBTITLE ON/OFF	<p>During playback, press SUBTITLE ON/OFF to switch the subtitle on or off.</p>	DVD HD DVD BD
AUDIO (🔊)	<p>During playback, press AUDIO repeatedly to hear a different audio language or audio track.</p> <p>Notes:</p> <ul style="list-style-type: none"> Some discs allow you to change audio selections only via the disc menu. If this is the case, press TITLE/POPUP or DISC MENU button and choose the appropriate audio from the selections on the disc menu. Immediately after you have switched sound, there may be a temporary discrepancy between the display and actual sound. On BD-ROM disc, the multi audio format (5.1CH or 7.1CH) is displayed with [MultiCH] in the on-screen display. 	DVD HD DVD BD

Notes on general features:

- When you turn on the player or replace a disc, the player returns to the initial default setting. Depending on a disc, a specific type of audio the disc has is output.
- Depending on the pre-recorded contents of the HD DVD or BD, some functions may not be available or may be operated differently than other media.

If a disc menu screen is displayed

DVD HD DVD BD

The menu screen may be displayed first after loading a disc which contains a menu.

Use the ◀ / ▶ / ▲ / ▼ buttons to select the title/chapter you want to view, then press ENTER to start playback.

Time Search **DVD BD**

To start playing at any chosen time on the disc:

1. Press DISPLAY during playback.
2. Press ▲ / ▼ to select the time clock icon and "--:--:--" appears.
3. Input the required start time in hours, minutes, and seconds from left to right. For example, to find a scene at 2 hours, 10 minutes, and 20 seconds, enter "21020" and press ENTER. If you enter the wrong numbers, press CLEAR to remove the numbers you entered. Then input the correct numbers.
4. Press ENTER to confirm. Playback starts from the selected time.

Note:

This function may not work on some disc or titles.

Marker Search **DVD BD**

To enter a Marker

You can start playback from up to nine memorized points. To enter a marker, press MARKER at the desired point on the disc. The Marker icon appears on the TV screen briefly. Repeat to enter up to nine markers.

To Recall or Clear a Marked Scene

1. During disc playback, press SEARCH. The marker search menu appears on the screen.
2. Within 10 seconds, press ◀ / ▶ to select a marker number that you want to recall or clear.
3. Press ENTER and playback starts from the marked scene. Or, Press CLEAR and the marker number is erased from the list.
4. You can play any marker by inputting its number on the marker search menu.

Notes:

- This function may not work on some disc or titles.
- All marked points are cleared if you press STOP (■) twice or unload the disc. (complete stop).

Screen Saver

The screen saver appears when you leave the player in Stop mode for about five minutes.

Using Color (A, B, C, D) Buttons

BD HD DVD

These buttons are available only during BD-J contents playback or during HD DVD interactivity contents playback. Use the appropriate buttons as indicated by the display. Depending on the disc contents, the functions of each button may differ.

Note:

On HD DVD disc, a menu or on-screen display may be disappeared after a while depending on the disc information.

Displaying Disc Information On-Screen

DVD HD DVD BD

You can display various information about the disc loaded on-screen.

1. Press DISPLAY to show various playback information.
The items displayed differ depending on the disc type or playing status.



2. During BD-ROM or DVD playback, you can select an item by pressing ▲ / ▼ and change or select the setting by pressing ◀ / ▶.
 - Title – Current title number/total number of titles.
 - Chapter – Current chapter number/total number of chapters.
 - Time – Elapsed playing time.
 - Audio – Selected audio language or channel.
 - Subtitle – Selected subtitle.
 - Angle – Selected angle/total number of angles.

Notes:

- If no button is pressed for a few seconds, the on-screen display disappears.
- A title number cannot be selected on some discs.
- An item may not be available on some discs or titles.
- If HD DVD interactivity or BD interactive title is playing back, some setting information is displayed on the screen but prohibited to be changed.

Hybrid Discs **BD HD DVD**

If you insert a Hybrid Disc, you must select a layer to play back.

Hybrid Disc?

- HD DVD Twin Format Disc with both HD DVD and DVD layers on one side
- BD-ROM Disc with both BD and DVD (or CD) layers on one side

1. Insert a Hybrid Disc.
The choice menu will appear.
2. Select the primary format (HD DVD or BD) or secondary format (DVD or CD) on the menu then press ENTER.
The selected playback format begins.

Notes:

- To change the format, press HOME then select [Movie] option and press ENTER. The choice menu will appear.
To play back the CD layer on the Hybrid Disc, select [Music] option on the HOME menu.
- You can only use ◀ / ▶, ENTER, OPEN/CLOSE and POWER buttons when the choice menu is displayed.
- You cannot change the format during playback.

Last Scene Memory **DVD**

This unit memorizes last scene from the last disc that is viewed. The last scene remains in memory even if you remove the disc from the unit or switch off the unit. If you load a disc that has the scene memorized, the scene is automatically recalled.

Notes:

- Settings are stored in memory for use any time.
- This unit does not memorize settings of a disc if you switch off the unit before commencing to play it.
- Last Scene Memory function for a previous DVD title is erased once a different DVD title is played.

Using the cursor function **HD DVD**

Some HD DVD discs may include game software and drawing software. If they do you can use the cursor function for some software.

1. Press CURSOR while a disc with support for cursor use is playing.
2. Use the eight direction buttons to move the cursor.

Tip:

Example: Game/drawing software

Move the cursor to select the game target or selection item. For details on actual operations, also refer to the operations guide for the disc.

Internet connection feature

BD HD DVD

Some HD DVD or BD-ROM discs may enable you to access special HD DVD or BD-ROM sites, if you connect the player to the Internet. For example, if an HD DVD or BD-ROM site includes content such as links to future movie trailers, you can watch the content on the player via the Internet.

1. Check the internet connection and configure. (See pages 17 and 23.)
2. Insert an HD DVD or BD-ROM disc with this feature and start the playback.
3. Select an item from the menu.

Playing an Audio CD or MP3/WMA files

The player can play Audio CDs and MP3/WMA files. Before playing MP3/WMA files, read “MP3/WMA audio file requirement” on right.

1. Insert Audio CD or a disc containing MP3/WMA files, or connect the USB Flash Drive containing MP3/WMA files
2. Press HOME and Home Menu appears.
3. Select [Music] then press ENTER. The MUSIC menu appears on the TV screen.

Note:

When the USB Flash Drive is connected and a disc is inserted simultaneously, the menu for selecting a media will appear. Select a media then press ENTER.

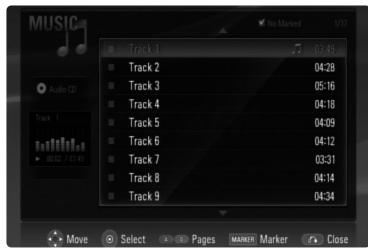

Example) Audio CD

4. Use ▲/▼ to select a track or file then press ► (PLAY). Playback starts. You can use variable playback functions. Refer to pages 25-26.
5. To stop playback at any time, press STOP (■).

Tips:

- The playback may start automatically if the Audio CD inserted.
- Select a folder then press ENTER and you can view the files in the folder. If you want to move to the upper directory, use ▲/▼ to highlight [UP Folder] and press ENTER.
- On the MUSIC menu, use red or blue color button to move to the previous or next page.
- The equalizer indicator is not coupled with the music in play back.
- If there is impossible code to express in the file name, it may be displayed as illegible.

MUSIC menu options

1. Use ▲ / ▼ to select a track or file on the MUSIC menu then press ENTER. The menu options appear.
2. Use ▲ / ▼ to select an option, then press ENTER.



- **[Play]** Starts playback the selected track or file.
- **[Select Play]** Plays back only the marked track(s) or file(s). Use MARKER for selecting the multiple files or tracks.
- **[Random]** Starts or stops random playback. By pressing ►► during random playback, the unit selects another track and resumes random playback.
- **[Unmark All]** Unmarks all marked files or tracks.
- **[Close]** Exits menu options. Also you can disappear it by pressing RETURN button.

Note:

You cannot use [Select Play] and [Random] functions simultaneously.

MP3/WMA audio file requirement

File extensions: “.mp3”, “.wma”.

Sampling frequency: 8 - 48 kHz

Bit rate: 8 - 320kbps

CD-R, DVD±R/RW/RAM, BD-R/RE Format: ISO 9660+JOLIET, UDF and UDF Bridge format.

Maximum Files/Disc: Less than 1999 (total number of files and folders)

Notes on MP3/WMA file

Depending on the size and number of the MP3/WMA files, it may take several minutes to read the contents of the media.

Viewing a JPEG file

This unit can play JPEG files. Before playing JPEG recordings, read "Photo file requirement" on below.

1. Insert a disc containing JPEG files, or connect the USB Flash Drive containing JPEG files
2. Press HOME and Home Menu appears.
3. Select [Photo] then press ENTER. The PHOTO menu appears on the TV screen.

Note:

When the USB Flash Drive is connected and a disc is inserted simultaneously, the menu for selecting a media will appear. Select a media then press ENTER.

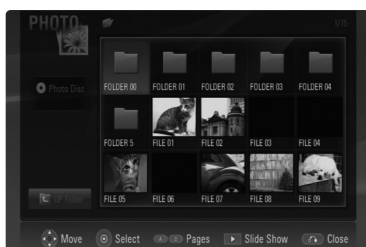

4. Use ▲▼◀▶ to select a file and press ENTER. The selected image is displayed in full screen.



5. To stop viewing at any time, press STOP (■). The PHOTO menu appears.

Tips:

- You can advance to the previous or next file by pressing ◀◀ or ▶▶ during viewing a photo file in full screen.
- You can start the slide show by pressing ▶ (PLAY) while the PHOTO menu appears.
- Select a folder then press ENTER and you can view the files in the folder. If you want to move to the upper directory, use ▲/▼ to highlight [UP Folder] and press ENTER.
- On the PHOTO menu, use red or blue color button to move to the previous or next page.
- If there is impossible code to express in the file name, it may be displayed as illegible.

Options during viewing a photo file in full screen

1. Follow steps 1-4 as shown left (Viewing a JPEG file).
2. You can use variable options during viewing a picture.
3. Use ▲▼◀▶ to select an option.

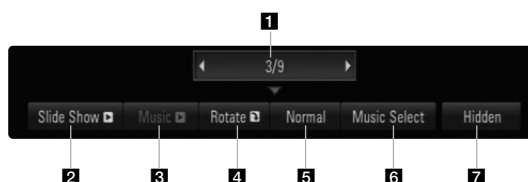

- 1 Use ◀▶ to advance to the previous or next file.
- 2 Use ENTER to start or pause the slide show.
- 3 Use ENTER to play or pause the background music. This option is available after the background music is selected using [Music Select] option.
- 4 Use ENTER to rotate the picture clockwise. This option is not available during slide show.
- 5 Use ENTER to set the Slide Show speed.
- 6 Selects the background music.
 - 1) Press ENTER and the menu will appear.
 - 2) Use ▲▼◀▶ to select a media or folder that there are music file(s).
 - 3) Press ENTER to confirm your selection.
- 7 Press ENTER to exit the option menu. To appear the menu again, press ENTER.

Photo file requirement

File extensions: ".jpg", ".jpeg", ".png"

Recommended size:

Less than 3,000 x 3,000 x 24 bit/pixel
Less than 3,000 x 2,250 x 32 bit/pixel

CD-R, DVD±R/RW/RAM, BD-R/RE Format:

ISO 9660+JOLIET, UDF and UDF Bridge format.

Maximum Files/Disc:

Less than 1999 (total number of files and folders)

Notes on JPEG file

- Progressive and lossless compression JPEG image files are not supported.
- Depending on the size and number of the JPEG files, it may take several minutes to read the contents of the media.

Reference

Controlling a TV with the Supplied Universal Remote Control

You can control the volume, input source, and power state of your TV with the supplied Universal Remote Control.

If your TV is listed in the table on pages 32-33, set the appropriate manufacturer code. Follow steps 1-2 as shown right.

You can control your TV using the buttons below.

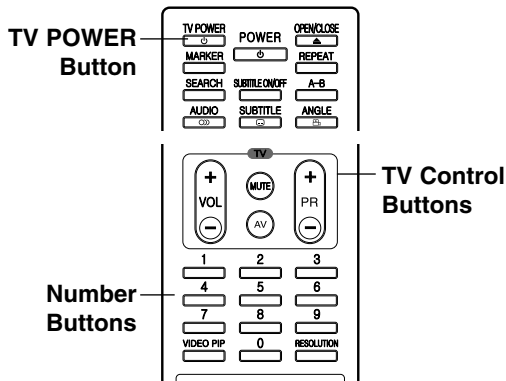

To program the remote to control the TV using the manufacturer code

If your TV is listed in the table on the next page, set the appropriate manufacturer code.

1. While holding down TV POWER button, press the number buttons to select the manufacturer code for your TV (Refer to table on the next page).
 - If more than one code number is listed, try entering them one at a time until you find the one that works with your TV.
2. Release TV POWER button.

Notes:

- Depending on your TV, some or all buttons may not function on the TV, even after entering the correct manufacturer code.
- If you enter a new code number, the code number previously entered will be erased.
- When you replace the batteries of the remote, the code number you have set may be reset to the default setting. Set the appropriate code number again.

By pressing	You can
TV POWER	Turn the TV on or off.
AV	Switch the TV's input source between the TV and other input sources.
PR +/-	Scan up or down through memorized channels.
VOL +/-	Adjust the volume of the TV.
MUTE	Temporarily turns TV sound OFF, press again to restore.

Note:

Depending on the unit being connected, you may not be able to control your TV using some of the buttons.

Code numbers of controllable TVs

If more than one code number is listed, try entering them one at a time until you find the one that works with your TV.

BRANDS	CODES	BRANDS	CODES	BRANDS	CODES
ADMIRAL	137 204	ELBE	058 144 157 160	HITACHI	011 013 015 017
ADYSON	159 219		192 246		021 022 023 024
AKAI	009 010 108 132	ELBIT	108 248		028 029 030 035
	133 135 139 140	ELECTROVENDA	108		039 040 041 048
	156 174 175	ELEKTRONIKA	108		053 054 055 056
AKURA	064 086 108 110	ELIN	108		057 120 127 128
	155 171	ELITE	064 149		129 134 135 140
ALBA	009 060 064	ELMAN	144		143 145 147 151
ALLSTAR	108	ELTA	010 171		156 159 173 193
AMSTRAD	006 025 157	EMERSON	108 204		219
AMWAY	108	ESC	108	HYPER	009 159 163 171
ANITECH	010 049 108 185	ETRON	133	ICE	009 010 064 108
	219	EUROPHON	144 159		171
ANTECNO	064	EXPERT	089	IMPERIAL	043 049 108 139
ARC EN CIEL	173 179 239	FENNER	171		144 154 165 255
ASA	087 102 108 235	FERGUSON	078 079 080 160	INGERSOLL	171
	236		182 195 198 199	INNO HIT	159 189 237
ASBERG	185		200 201 202	INTERBUY	010
ASORA	171	FINLANDIA	194 195	INTERCORD	233
ATLANTIC	089 197	FINLUX	008 087 102 104	INTERFUNK	108 109 113 130
AUDIOSONIC	085		105 107 108 140		133 134 135 137
AUTOVOX	159 163 197		144 159 161 174		141 146 147 148
BANK	232		189 235 236		165 179 210
BEKO	045 085 086 108	FIRST-LINE	144	INTERVISION	010 086 108 132
	250	FISHER	086 208 222 233		144 166
BESTAR	086	FORMENTI	108 149	IRRADIO	163 235 237
BLAUPUNKT	031 091 092 096	FRABA	108	ITC	144 159
	097 098 099 210	FRONTECH	136 171 220	ITS	009 010 064 171
	253	FUBA	073 109	ITT	141 151 186
BONDSTEC	163	FUJITSU GENERAL	088 159 197	JVC	009 169
BOSCH	210	FUNAI	010	KAIDO	136
BRANDT	173 179 225 239	GALAXIS	108 185	KAPSCH	089 147 148 197
ELECTRONIQUE		GALERIA	171	KARCHER	084 108
BRIONVEGA	204	GBC	137 144 171	KATHREIN	109
BSR	144	GEC	011 108 129 147	KAWA	009
BUSH	009 136 139 144		159 189	KENDO	060 108 137 157
	232	GELOSO	064 137 144 164	KENNEDY	197
CENTURY	165 204		171	KNEISSEL	108
CGE	139 165 210	GENERAL	171	KONKA	009
CIE	025 108 170	GENERAL TECHNIC	171	KORTING	086 204 209
CLATRONIC	009 010 064 108	GOLDHAND	159 171	KUBA	233
	144 149 159 164	GOLDSTAR	038 050 108 110	KUBA ELECTRONIC	233
	165 171 185		136 144 159 163	KURA	134
CLARIVOX	033		166 171 191 219	LENCO	108 170
CONDOR	108 149 191		237	LG	001(Default) 038
CONIC	219	GOODMANS	009 064 108 109		050 108 110 136
CONTEC	171 222		110 120 159 170		144 159 163 166
CONTINENTAL	173 179 225 239		171		171 191 219 237
EDISON		GORENJE	086	LIESENKOTTER	108 210
COSMOS	108	GPM	010 064	LIFETEC	010 064 108 170
CROSLEY	165 204	GRANADA	027 105 108 111	LOEWE	109 113 204 205
CROWN	084 085 086 108		121 134 140 159	LOGIK	070 227
	144 171 185		162 167 187 194	LUMA	137 197
CS-ELECTRONICS	064		195 238	LUXOR	102 104 132 133
DAEWOO	051 108 120 127	GRUNDIG	091 092 093 094		134 135 138 140
	170		095 097 098 100		143 145 153 156
DANSAI	010 219		101 172 232 238		174 186 237
DE GRAAF	108 134	HCM	010 108 159 171	M ELECTRONIC	103 104
DECCA	070 108 159 161	HIFIVOX	173 179 239	MAGNADYNE	163 164 204
	162 184 189 190	HINARI	010 064 108 133	MAGNAFON	199
	206		171	MAGNASONIC	108
DECCAVIDEO	108	HIT	204	MARANTZ	108
DUAL	233			MARSHAL	064
DUMONT	204			MATSUI	009 016 025 060
					061 062 063 070
					108 131 136 152
					154 159 171 172

BRANDS	CODES
MERRIT	132
METZ	047 092 097 098 100 101 108 204 207 254
MITSUBISHI	075 076 077 097 113 204 222 224 240
MIVAR	044 042 159 235
MNARTT	007
MTC	086 109 134
MULTITECH	136 159 171 185
MURPHY	232
NAONIS	137
NECKERMANN	037 059 060 092 098 100 101 108 109 113 115 118 119 134 135 137 143 157 159
NEI	064 108
NIKKAI	219
NIKKO	108
NOBLIKO	232 235
NOGAMATIC	173 179 239
NOKIA	014 019 032 102 103 104 108 132 133 134 135 138 140 141 145 146 147 148 156 174
NORDMENDE	129 173 179 180 181 193 195 225 226 228 239
NORMN	108
NOVA	087
OCEANIC	032 103 104 135 140 156
OKANO	108
ONWA	009 010 064
ORAVA	108
ORBITER	086
ORION	025 059 060 061 062 064 070 108 110 118 219
OSAKE	106
OTTO-VERSAND	002 005 009 014 059 060 081 082 083 085 092 097 098 100 101 108 109 111 113
PAEL	235
PANASONIC	002 003 005 167 168 229
PATHE CINEMA	144
PATHE MARCONI	173 179 225 239
PHILCO	090 108 139 144 148 165 204
PHILIPS	065 066 067 068 069 092 108 109 111 112 114 115 116 119 122 123 124 125 193 212 251 252
PIONEER	193
PRANDONI-PRINCE	137 235
PRIMA	219
PRO VISION	108

BRANDS	CODES
PROFEX	108 136 171
PROFITRONIC	108
QUELLE	002 010 014 019 025 059 060 072 084 086 087 088 092 097 098 100 101 102 175
RADIOLA	108
RADIOTONE	010 085 108 171
REDIFUSSION	187
REVOX	109
REX	088 089 137 157 158 164 197 246 247
RFT	064 085 135 204
RITAR	138
ROADSTAR	108
ROSITA	171
SABA	079 146 147 173 179 181 193 195 225 226 239
SAISHO	025 060 070 136 159
SAKIO	171
SALORA	019 032 103 104 132 133 134 135 137 138 140 142 143 145 150 156 174 237 241
SAMBERS	235
SAMSUNG	004 010 050 086 108 117 126 171 220 237
SANY	193
SANYO	014 018 019 020 032 034 071 086 087 189 218 221 222 223
SCHNEIDER	009 064 088 108 133 141 159 163 233
SEG	010 064 108 144 159 165 171 185 219
SEI-SINUDYNE	025 108 204 212
SELECO	088 089 137 157 197 222
SENTRA	064 133
SHARP	081 082 083 222
SHINTOM	108
SHINTOSHI	108
SHIVAKI	108
SIAREM	204
SIEMENS	092 096 097 098 100 101 108 210 218 219 221
SIESTA	085
SILVER	010 064
SINGER	108 164 204
SINUDYNE	118 131
SMARAGO	172
SOLAVOX	133
SONOLOR	140 156
SONTEC	108
SONY	072 074 211 212 213 214 215 216 217 222

BRANDS	CODES
SPECTRA	170
STARLITE	108 171
STARLUX	171
STERN	088 089 137 157 197
SUNSTAR	108 171
SUPERTECH	108 139 152 171
TADISTAR	108
TASHIKO	108 159 218
TEC	108 139 144 159 170 171
TECHLINE	185
TECHNISAT	108 165
TECNISON	108 171
TEKON	171
TELEAVIA	173 178 179 225 239
TELEFUNKEN	079 177 179 181 193 195 200 210
TELEOPTA	171
TELERNT	109
TELETECH	165 171
TELETEXT	115
TELETON	088
TELETON	089 134 159 197
TENSAI	064 108 144 149 171 191
TENSON	171
TESLA	204
THOMSON	052 078 079 134 173 178 179 181 193 195 225 239
THORN	011 014 016 018 026 028 066 072 075 087 097 102 108 116 135 141 145 146 160
THORN-FERGUSON	160 188 200 227
TOSHIBA	012 016 026 036 037 222 232
TOWADA	144 185
TRISTAR	010 064
TRIUMPH	025 219 236
UHER 089	108 109 149 185 197 233
ULTRAVOX	108 164 185 204
UNIVERSUM	174
UNIVOX	204
VESTEL	108
VIDEOSAT	165
VIDEOTON	178 193
VIDEOWAY	230
VISION	108 149
VOXSON	137 204
WALTHAM	178
WATSON	064 108 149 171
WEGA	208 222
WHITE	108 110 149
WESTINGHOUSE	
YOKO	010 064 108 136 144 159 164 170 171
ZANUSSI	137 197
ZENITH	231

Language Codes

Use this list to input your desired language for the following initial settings:
Disc Audio, Disc Subtitle, Disc Menu.

Language	Code	Language	Code	Language	Code	Language	Code
Abkhazian	6566	Fiji	7074	Lingala	7678	Singhalese	8373
Afar	6565	Finnish	7073	Lithuanian	7684	Slovak	8375
Afrikaans	6570	French	7082	Macedonian	7775	Slovenian	8376
Albanian	8381	Frisian	7089	Malagasy	7771	Somali	8379
Ameharic	6577	Galician	7176	Malay	7783	Spanish	6983
Arabic	6582	Georgian	7565	Malayalam	7776	Sudanese	8385
Armenian	7289	German	6869	Maltese	7784	Swahili	8387
Assamese	6583	Greek	6976	Maori	7773	Swedish	8386
Aymara	6589	Greenlandic	7576	Marathi	7782	Tagalog	8476
Azerbaijani	6590	Guarani	7178	Moldavian	7779	Tajik	8471
Bashkir	6665	Gujarati	7185	Mongolian	7778	Tamil	8465
Basque	6985	Hausa	7265	Nauru	7865	Tatar	8484
Bengali; Bangla	6678	Hebrew	7387	Nepali	7869	Telugu	8469
Bhutani	6890	Hindi	7273	Norwegian	7879	Thai	8472
Bihari	6672	Hungarian	7285	Oriya	7982	Tibetan	6679
Breton	6682	Icelandic	7383	Panjabi	8065	Tigrinya	8473
Bulgarian	6671	Indonesian	7378	Pashto, Pushto	8083	Tonga	8479
Burmese	7789	Interlingua	7365	Persian	7065	Turkish	8482
Byelorussian	6669	Irish	7165	Polish	8076	Turkmen	8475
Cambodian	7577	Italian	7384	Portuguese	8084	Twi	8487
Catalan	6765	Japanese	7465	Quechua	8185	Ukrainian	8575
Chinese	9072	Javanese	7487	Rhaeto-Romance	8277	Urdu	8582
Corsican	6779	Kannada	7578	Rumanian	8279	Uzbek	8590
Croatian	7282	Kashmiri	7583	Russian	8285	Vietnamese	8673
Czech	6783	Kazakh	7575	Samoan	8377	Volapük	8679
Danish	6865	Kirghiz	7589	Sanskrit	8365	Welsh	6789
Dutch	7876	Korean	7579	Scots Gaelic	7168	Wolof	8779
English	6978	Kurdish	7585	Serbian	8382	Xhosa	8872
Esperanto	6979	Laothian	7679	Serbo-Croatian	8372	Yiddish	7473
Estonian	6984	Latin	7665	Shona	8378	Yoruba	8979
Faroese	7079	Latvian, Lettish	7686	Sindhi	8368	Zulu	9085

Area Codes

Choose an Area code from this list.

Area	Code	Area	Code	Area	Code	Area	Code
Afghanistan	AF	Ethiopia	ET	Malaysia	MY	Saudi Arabia	SA
Argentina	AR	Fiji	FJ	Maldives	MV	Senegal	SN
Australia	AU	Finland	FI	Mexico	MX	Singapore	SG
Austria	AT	France	FR	Monaco	MC	Slovak Republic	SK
Belgium	BE	Germany	DE	Mongolia	MN	Slovenia	SI
Bhutan	BT	Great Britain	GB	Morocco	MA	South Africa	ZA
Bolivia	BO	Greece	GR	Nepal	NP	South Korea	KR
Brazil	BR	Greenland	GL	Netherlands	NL	Spain	ES
Cambodia	KH	Herd and McDonald Islands	HM	Netherlands Antilles	AN	Sri Lanka	LK
Canada	CA	Hong Kong	HK	New Zealand	NZ	Sweden	SE
Chile	CL	Hungary	HU	Nigeria	NG	Switzerland	CH
China	CN	India	IN	Norway	NO	Taiwan	TW
Colombia	CO	Indonesia	ID	Oman	OM	Thailand	TH
Congo	CG	Israel	IL	Pakistan	PK	Turkey	TR
Costa Rica	CR	Italy	IT	Panama	PA	Uganda	UG
Croatia	HR	Jamaica	JM	Paraguay	PY	Ukraine	UA
Czech Republic	CZ	Japan	JP	Philippines	PH	United States	US
Denmark	DK	Kenya	KE	Poland	PL	Uruguay	UY
Ecuador	EC	Kuwait	KW	Portugal	PT	Uzbekistan	UZ
Egypt	EG	Libya	LY	Romania	RO	Vietnam	VN
El Salvador	SV	Luxembourg	LU	Russian Federation	RU	Zimbabwe	ZW

Troubleshooting

Symptom	Possible Cause	Correction
No power.	<ul style="list-style-type: none"> The power cord is disconnected. 	<ul style="list-style-type: none"> Plug the power cord into the wall outlet securely.
The power is on, but the player does not work.	<ul style="list-style-type: none"> No disc is inserted. 	<ul style="list-style-type: none"> Insert a disc. (Check the disc indicator in the display window is lit.)
No picture.	<ul style="list-style-type: none"> The TV is not set to receive DVD signal output. 	<ul style="list-style-type: none"> Select the appropriate video input mode on the TV.
	<ul style="list-style-type: none"> The video cable is not connected securely. 	<ul style="list-style-type: none"> Connect the video cable securely.
	<ul style="list-style-type: none"> The selected resolution is not capable with your TV. 	<ul style="list-style-type: none"> Select another resolution using RESOLUTION button.
No sound.	<ul style="list-style-type: none"> The equipment connected with the audio cable is not set to receive disc signal output. 	<ul style="list-style-type: none"> Select the correct input mode of the audio receiver so you can listen to the sound from the player.
	<ul style="list-style-type: none"> The power of the equipment connected with the audio cable is turned off. 	<ul style="list-style-type: none"> Turn on the equipment connected with the audio cable.
	<ul style="list-style-type: none"> The [AUDIO] options are set to the wrong position. 	<ul style="list-style-type: none"> Set the [AUDIO] options to the correct position. (See page 21)
The player does not start playback.	<ul style="list-style-type: none"> An unplayable disc is inserted. 	<ul style="list-style-type: none"> Insert a playable disc. (Check the disc type and regional code.)
	<ul style="list-style-type: none"> The rating level is set. 	<ul style="list-style-type: none"> Change the rating level.
The Remote Control does not work properly.	<ul style="list-style-type: none"> The Remote Control is not pointed at the remote sensor on the player. 	<ul style="list-style-type: none"> Point the Remote Control at the remote sensor of the player.
	<ul style="list-style-type: none"> The Remote Control is too far from the player. 	<ul style="list-style-type: none"> Operate the Remote Control closer to the player.

Resetting the Player

If you observe any of the following symptoms...

- When the Player is plugged in, but the power will not turn on or off.
- When the display window is not working.
- When the Player does not operate normally.

You can reset the Player as follows:

- Press and hold the POWER button for more than five seconds. This will force the Player to power off. Press the POWER button again to turn the Player back on.
- Unplug the power cord and then plug the power cord again after more than five seconds.

Customer Support

You can update the Player using the latest software to enhance the products operation and/or add new features. To obtain the latest software for this player (if updates have been made), please visit <http://sg.lgservice.com> or contact LG Electronics customer care center.

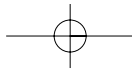

Specifications

General

Power requirements:	AC 110-240V, 50/60Hz
Power consumption:	25W
Dimensions (W x H x D):	Approx. 16.9 x 3.0 x 10.6 mm (430 x 77 x 269 inches)
Net Weight (Approx.):	3.8 kg (8.3 lbs)
Operating temperature:	5 °C to 35 °C (41 °F to 95 °F)
Operating humidity:	5 % to 90 %

Outputs

VIDEO OUT:	1.0 V (p-p), 75 Ω , sync negative, RCA jack x 1
COMPONENT VIDEO OUT:	(Y) 1.0 V (p-p), 75 Ω , sync negative, RCA jack x 1 (Pb)/(Pr) 0.7 V (p-p), 75 Ω , RCA jack x 2
HDMI OUT (video/audio):	19 pin (HDMI standard, Type A)
ANALOG AUDIO OUT:	2.0 Vrms (1 kHz, 0 dB), 600 Ω , RCA jack (L, R) x 1
DIGITAL OUT (OPTICAL):	3 V (p-p), Optical jack x 1

System

Laser:	Semiconductor laser, wavelength: 405nm / 650 nm
Signal system:	Standard PAL/NTSC Colour TV system
Frequency response:	20 Hz to 20 kHz (48 kHz, 96 kHz, 192 kHz sampling)
Signal-to-noise ratio:	More than 100 dB (ANALOG OUT connectors only)
Harmonic distortion:	Less than 0.008%
Dynamic range:	More than 95 dB
LAN port:	Ethernet jack x 1, 10BASE-T/100BASE-TX
Accessories:	HDMI cable (1) Component video cable (1) Video cable (1) Audio cable (1) Remote control (1) Batteries (2) Cloth for cleaning the surfaces of the player (1)

Note: Design and specifications are subject to change without prior notice.

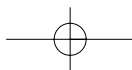

The unit's Audio Output Specifications

Source Format	Jack/ Setting	Analog Output Stereo	SPDIF (DIGITAL AUDIO OUT) *5		
			PCM Stereo	DTS Re-encode *3 *6	Primary Pass-Thru *1
Dolby Digital		PCM 2ch	PCM 2ch	DTS	Dolby Digital
Dolby Digital Plus		PCM 2ch	PCM 2ch	DTS	Dolby Digital
Dolby TrueHD		PCM 2ch	PCM 2ch	DTS	PCM 2ch
DTS		PCM 2ch	PCM 2ch	DTS	DTS
DTS-HD		PCM 2ch	PCM 2ch	DTS	DTS
Linear PCM 2ch		PCM 2ch	PCM 2ch	DTS	PCM 2ch
Linear PCM 5.1ch		PCM 2ch	PCM 2ch	DTS	PCM 2ch
Linear PCM 7.1ch		PCM 2ch	PCM 2ch	DTS	PCM 2ch
MPEG		PCM 2ch	PCM 2ch	PCM 2ch	PCM 2ch

Source Format	Jack/ Setting	HDMI OUT				
		PCM Stereo	PCM Multi-Ch *3	DTS Re-encode *6	Primary Pass-Thru *1, *2	
					HDMI 1.2	HDMI 1.3
Dolby Digital		PCM 2ch	PCM 5.1ch	DTS	Dolby Digital	Dolby Digital
Dolby Digital Plus		PCM 2ch	PCM 5.1ch	DTS	Dolby Digital	Dolby Digital
Dolby TrueHD		PCM 2ch	PCM 2ch	DTS	PCM 2ch	PCM 2ch
DTS		PCM 2ch	PCM 5.1ch	DTS	DTS	DTS
DTS-HD		PCM 2ch	PCM 5.1ch	DTS	DTS	DTS
Linear PCM 2ch		PCM 2ch	PCM 2ch	DTS	PCM 2ch	PCM 2ch
Linear PCM 5.1ch		PCM 2ch	PCM 5.1ch	DTS	PCM 5.1ch	PCM 5.1ch
Linear PCM 7.1ch		PCM 2ch	PCM 7.1ch	DTS	PCM 7.1ch *4	PCM 7.1ch *4
MPEG		PCM 2ch	PCM 2ch	PCM 2ch	PCM 2ch	PCM 2ch

Notes:

- *1 The secondary and interactive audios may not be included in the output bitstream if [SPDIF] or [HDMI] option is set to [Primary Pass-Thru].
- *2 This player automatically selects the HDMI audio according to the decoding capability of the connected HDMI device if [HDMI] option is set to [Primary Pass-Thru].
- *3 The [PCM Multi-CH]/[Primary Pass-Thru] setting of the [HDMI] option and [DTS re-encode] setting of the [SPDIF] option cannot be set together. If you set the [HDMI] option to [PCM Multi-CH] or [Primary Pass-Thru], the [SPDIF] option is set to [PCM Stereo] automatically. Also, if you set the [SPDIF] option to [DTS Re-encode] and the [HDMI] option is set to [PCM Stereo] automatically. (The Linear PCM audio source may output as PCM stereo audio from DIGITAL AUDIO OUT jack if the [HDMI] option is set to [Primary Pass-Thru] or the [SPDIF] option is set to [DTS Re-encode].)
- *4 The Linear PCM 5.1ch/7.1ch audio source recorded at 192 kHz sampling frequency will output as PCM stereo audio.
- *5 The sampling frequency of HDMI/SPDIF (DIGITAL AUDIO OUT) is limited to 96 kHz.
- *6 The audio is limited to 48 kHz and 5.1 ch if [HDMI] or [SPDIF] option is set to [DTS re-encode]. The DTS audio will output on BD and HD DVD advanced disc, and the original audio will output on the other discs.
 - The audio is always output as PCM 48kHz/16 bit during Audio CD or MP3/WMA file is playing back.
 - The MPEG audio source is always output as PCM 2ch.

Open source software notice

The following GPL executables and LGPL/MPL libraries used in this product are subject to the GPL2.0/LGPL2.1/MPL1.1 License Agreements:

GPL EXECUTABLES:

Linux kernel 2.6, bash, busybox, sysutils, net-tools, dhcpcd, tinylogin, mtd-utils

LGPL LIBRARIES:

uClibc, DirectFB, GnuTLS, iconv, cairo

MPL:

Mozilla 1.0

LG Electronics offers to provide source code to you on CD-ROM for a charge covering the cost of performing such distribution, such as the cost of media, shipping and handling upon e-mail request to LG Electronics at: opensource@lge.com

This offer is valid for a period of three(3) years from the date of the distribution of this product by LG Electronics.

You can obtain a copy of the GPL, LGPL licenses from <http://www.gnu.org/licenses/> and a copy of MPL license from <http://www.mozilla.org/MPL/>

This software is based in part on the work of the Independent JPEG Group copyright © 1991-1998, Thomas G. Lane.

This product includes

- Freetype library : Copyright © 2003 The FreeType Project (www.freetype.org).
- libpng library : Copyright © 2004 Glenn Randers-Pehrson
- Zlib compression library: Copyright © 1995-2002 Jean-loup Gailly and Mark Adler
- cryptographic software written by Eric Young (ey@cryptsoft.com).
- software written by Tim Hudson (tjh@cryptsoft.com).
- software developed by the OpenSSL Project for use in the OpenSSL Toolkit. (<http://www.openssl.org>)

This product includes other open source software.

- Copyright © David L. Mills 1992-2006
- Copyright © 1998-2003 Daniel Veillard.
- Copyright © 1998, 1999 Thai Open Source Software Center Ltd.
- Copyright © 1990 The Regents of the University of California.
- Copyright © 1998-2005 The OpenSSL Project.

All rights reserved.

Permission is hereby granted, free of charge, to any person obtaining a copy of this software and associated documentation files (the "Software"), to deal in the Software without restriction, including without limitation the rights to use, copy, modify, merge, publish, distribute, sublicense, and/or sell copies of the Software, and to permit persons to whom the Software is furnished to do so, subject to the following conditions:

THE SOFTWARE IS PROVIDED "AS IS", WITHOUT WARRANTY OF ANY KIND, EXPRESS OR IMPLIED, INCLUDING BUT NOT LIMITED TO THE WARRANTIES OF MERCHANTABILITY, FITNESS FOR A PARTICULAR PURPOSE AND NONINFRINGEMENT. IN NO EVENT SHALL THE AUTHORS OR COPYRIGHT HOLDERS BE LIABLE FOR ANY CLAIM, DAMAGES OR OTHER LIABILITY, WHETHER IN AN ACTION OF CONTRACT, TORT OR OTHERWISE, ARISING FROM, OUT OF OR IN CONNECTION WITH THE SOFTWARE OR THE USE OR OTHER DEALINGS IN THE SOFTWARE.

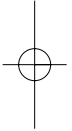
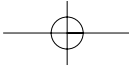

P/NO : MFL36364151

